

# AHD/TVI Installation and Operation Manual

## **Infrared Intelligent High Speed Dome**

---

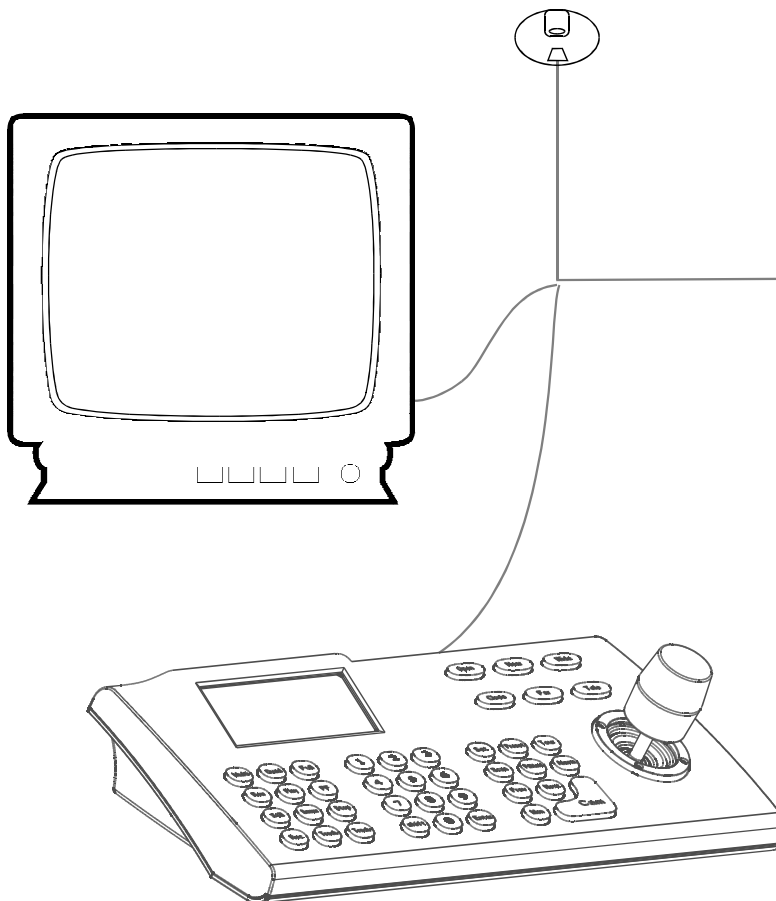

# TABLE OF CONTENT

1. Notice-----	1
2. Performance-----	2
2.1 PTZ technology parameter-----	2
2.2 Camera parameter-----	2
2.3 Performance & Feature-----	3
3. Function and operation instruction-----	5
3.1 Set camera ID-----	5
3.2 Auto-run motion-----	5
3.3 Camera control-----	6
3.4 Monitor function-----	6
4. System setting-----	8
4.1 Basic operation-----	8
4.1.1 Self-testing-----	8
4.1.2 Call the main menu-----	8
4.1.3 The operational ways of keyboard and menu-----	8
4.2 Edit dome label-----	9
4.3 Display initial information-----	10
4.4 Display setting-----	11
4.5 System setting-----	12
4.5.1 Auto flip-----	12
4.5.2 Speed proportion pan-----	12
4.5.3 Park action-----	13
4.5.4 Power up action-----	13
4.5.5 Fan startup by temperature-----	13
4.5.6 Advance setting-----	14
4.6 Clear -----	15
4.7 Password setup -----	16
4.8 Clock setting -----	17
4.9 Dome address -----	18
5. Camera setting-----	19
5.1 Zoom speed-----	19
5.2 Digital zoom control-----	20
5.3 Back light compensation-----	21
5.4 Slow shutter-----	22
5.5 Line Sync control-----	22
5.6 WDR control-----	23
5.7 Video output-----	23
5.8 Advance setting-----	24

5.8.1 AE mode-----	24
5.8.2 DAY/NIGHT mode-----	25
5.8.3 White balance mode-----	25
5.8.4 Image setting function-----	26
5.8.5 Focus-----	26
6. Function setting -----	27
6.1 Preset -----	27
6.2 Scan-----	28
6.3 Pattern-----	29
6.4 Tour-----	30
6.5 Zone-----	31
6.6 Time running-----	32
6.7 Set auto-tracking-----	33
7. Privacy zone masking-----	34
8. Alarm function -----	35
9. Appendix-----	37
9.1 Menu index-----	37
9.2 24VAC Wire Diameter and Transmission Distance Comparison chart-----	38
9.3 Domestic and Abroad Wire Gauge Conversion Chart-----	39
9.4 Rs485 Bus Basic Knowledge-----	40
9.5 DIP switch setup-----	42
9.5.1 Baud rate setting-----	42
9.5.2 Protocol setting-----	42
9.5.3 ID setting-----	42
10.Installation instruction-----	47
10.1 Caution-----	47
10.2 Distributing the Line in Security-----	47
10.3 Lightning Proof and Surge Proof-----	48
10.4 Water Proof-----	48
10.5 The preparation of installation-----	48
10.6 Structure introduction-----	49
10.7 Basic size graph-----	49
10.8 Installation -----	50
10.9 Cabling connection-----	52
10.10 Electrification inspection-----	52
11.Maintance service terms-----	53

## 1. Precaution

### Ø Electrical safety

Conform to country and local electrical safety standard when using or installing the product.

### Ø Transportation

The PTZ should be protected against extremes of pressure, vibration and humidity during storage installation and transportation. The infrared PTZ camera is transported by integrated packing.

### Ø Installation of care

Please refer to user installation manual when installation. Please pick up the Infrared parts gently and do not press it, or else, which will cause the malfunction of parts; the lens of Infrared belong to optional products, please do not touch it by your hand to avoid scraping it.

### Ø Requirements to service personnel

All the service work should be done by qualified technicians.

### Ø Do not disassemble the pan/tilt module

Do not disassemble screws, and don't maintain the parts in the Pan/Tilt by yourself. Only qualified and authorized personnel can undertake repairs.

### Ø Environmental requirements

= Requirements for PTZ:

Environmental temp: -40~+60℃

Humidity: <90%

Air pressure: 86~106Kpa

AC Power supply: 24V/2500MA, 50/60HZ

### Ø Don't place the camera to be shoot by strong light objects

Don't place the camera to be shoot by strong light objects. Don't point the PTZ to the sun or other bright objects when in use or not. It may affect image quality.

### Ø Function of waterproof

Our product has good water-proof, humidity-proof and dust-proof, which pass the standard of IP66. But it's not good to stay in the humidity environment, which will make some machinery parts broken.

## 2. 1 Technology parameter

Electrical:		Setting:	
Power supply	AC24V	Baud rate ( RS485 )	2400/4800/9600/19200bps
Consumption	( PTZ+IR light ) 33w ( PTZ+IR light+Heater ) 53w	Protocol	Sixteen protocols, including Pelco, Kalatel, Philips, Diamond, etc.
Decoder	Built-in	Address setting	0-254
Operation:		Environmental:	
Pan rotation	360° continuously	Operational environment	-40 ~ +60°C
Tilt rotation	Tilt180° , with auto flip	Environmental humidity	0—95% no compensation
Rotation speed	Pan0.4 ~ 180°/S Tilt0.4 ~ 80°/S	Protection grade	IP66, Weather proof housing, 4000V lightning proof surge proof
Alarm function	7 alarm input/2 alarm output	<b>Physical:</b>	
Preset	128presets	Mount	wall mount pendant mount
Surveillance	Preset、Tour、Scan、Pattern	Infrared night vision	Above 80 meters

## 2. 2 Camera parameter

Spec \ Model	KGD	KED
System	1080P30/25, 720P60/50, 720P30/25	
Sensor	1/2.8 Type CMOS Sensor	
Effective pixels	2MP	
Syn	Inner	
Resolution	1920*1080、1280*720	
Minimum illumination	Color 1.0Lux, W/B 0.05Lux	
Lens	20X optical	
Focal length	4.7mm ~ 94mm	
View of angle	Wide 55.5° /Tele 3.0°	
Iris	AUTO/Manual	
Focus	AUTO/Manual	
White balance	AUTO/Manual	
BLC	OFF/ON	
S/N	≥50dB	
Electronic shutter	1/60-1/10000	
Video output	AHD	TVI
Port of video output	Female BNC	
WDR	Support	

### **2.3 PTZ Performance and Feature**

The intelligent Pan/tilt was complete new design, compact structure, built-in constant temperature device and rapidly heat dissipation from chip; wiper function can retain full resolution picture in raining day; AMP socket is convenient for installation; Infrared LED range more than 60 meters; Camera rotate flexibly with low noise, wide range capture and certain auto-functions can provide perfect quality of image for customer.

#### **∅ Built-in receiver**

- All configurable options stored in main control board to protect against power cuts
- Integrate design and high durability
- 01-80 preset support auto-tour, and each tour can store up to 16 presets.
- 4 pattern tours
- Built-in direction indicator
- Built-in clock setting function
- Rs485 Bus communication or American Dynamics Manchester code
- Support 24 masking zones at most ( This function is decide by the parameter of built-in camera, if the camera has not this function, this option is invalid. )
- 7 alarm input, 2 alarm output.
- 128 presets can be randomly stored
- 4 scan
- Built-in temperature indicator

#### **∅ Pan Tilt Feature**

- Aluminum alloy material and anti-violence design surface is well hidden and rapid heat removal; Level of protection achieves IP66.
- Precise stepping motor drives the pan to run smoothly and react sensitivity.
- Integrated design, compact structure, easy to disassemble.
- Exquisite mechanical drive, support to rotate pan 360° continuously and tilt 0° ~ +105° , and may rotate 180° with auto flip.
- Pan 0.4° /s to rotate slowly, and the image doesn't vibrate.

#### **∅ Built-in digital camera**

- High sensitivity, high resolution, and integrated digital processing
- Auto-focus
- Auto brightness control
- IR cut filter
- Auto slow shutter
- Auto-Iris
- Auto white balance
- Auto back light compensation

#### **∅ OSD menu**

- All English menu can be selected.
- Visual OSD menu. Revising the PTZ's information and parameter by keyboard and OSD menu, and it is easy to operate.
- Set park action function and set presets, or run scan, pattern, tour, etc during idle time.
- Auto-resume movement or carry out pointed movements after power up.

## Ø Internal temperature test

- Set time display
- When the temperature exceeds the limit, the screen will display alarm information.
- When the temperature is under the limit, the PTZ will delay to startup, and when the heat device is heated and got higher than low limit temperature to startup.
- According to the temperature, the fan measures if it is to start or not, and prolong the life of fan.

## Ø Time running

By the menu “Time running” ,user may set time running function everyday, and set different four actions in four different time in one day, including preset, scan, pattern and tour.

## Ø Night View Function

Infrared LED range more than 80 meters, can manual control or auto-control infrared LED ON/OFF, manual control through keyboard can turn infrared LED ON/OFF. If auto-control working, image color will be switch to black and white when in low brightness, black and white will be switch to color when in high brightness.

## Ø Wiper function

Wiper function can be set ON/OFF by calling 63 preset or OSD menu. In the raining day, the wiper can not only ensure the high quality image, but also cleanup the dirtiness on the surface of lens.

### 3. Function Instruction

This passage mainly describes the main function and general principle of intelligence PTZ, and not refer to the concrete operation methods. Different system platform has different operation methods, generally, should according to the system manufactory's operation manual. Please contact dealer to get necessary information, there are some particular requirements and operations under specific condition.

#### 3.1 Camera ID

There are two 8digits code switch SW1 and SW2 under the right side cover, SW1 is for setting the address of the PTZ and SW2 is for setting communication baudrate and controlling protocol. (For detail setting, please refer to 10.5 DIP switch setting)

Besides the factory protocol(FACTORY), the PTZ is compatible with various popular protocols, such as PECLO-D, PECLO-P, ERNITEC, VCL, MOLYNX, VICON, SANTACHI, PANASONIC, SAMUNG, DIAMOND, KALATEL, LILIN, PHILIPS, VIDO B02, AD and so on.

Any controlling command must base on the objective camera address, and the camera only answer to the controlling command address which coincide with itself. There are three kinds of camera address:

- Common address: Use camera's switch number to set address 1-8 bits, the address range is 1-254.
- Debug address: (Only factory protocol and PELCO can be set) if camera ID is set 0, user may select any address to control the PTZ.

#### 3.2 Auto-run motion

##### Ø Focus/speed proportion pan

When manually adjusting, for far focus situation, the PTZ responds at a high-speed so that touching rocker slightly may make picture move rapidly, thus cause the picture to lose. To base on humanized design, the PTZ automatically adjust pan and tilt rotation according to zoom near and far, which make it is convenient to operate manually to make tracking for the object. In the menu, you may change system parameter setting proportion pan as ON to run this function.

##### Ø Auto flip

If user holds the joystick in the down position, the camera rotates pan 180 degrees, then the camera rotates tilts up to 180 degrees. In the menu, you may set the system parameter setting AUTO FLIP as ON to run this function.

##### Ø Park action

By the menu “ park time” and “park action” , user may set auto-call preset or run tour, pattern, and scan, etc after pointing a few minutes if the PTZ doesn't run any motions.

##### Ø Power up action

By the menu “ power up action” , after the PTZ powers up or restarts, user may set auto- resume movements before power up and auto- call preset or run tour, pattern, and scan etc .



### 3. 3 Camera control

- **Magnification control**

The user can control “Wide/Tele” to adjust zoom far and near of the image by keyboard controller to obtain panoramic image or close view that you need. The PTZ support digital zoom and optical zoom.

- **Focus control**

System defaults Auto focus. When the lens changes, camera will auto-adjust focus according to the center of the image to get legible image; user can also manually focus to get desire image by operating keyboard “FAR/NEAR” . When operating keyboard joystick, camera resumes to auto focus.

The camera cannot auto focus in the following status:

- Target is not the center of the image
- Observation the target near and far at the same time, can not be clear at the same time.
  - Target is a strong light object, such as neon light, spotlight , etc.
  - Target moves too fast
  - Target area such as wall
  - Target is too dark or vague
  - Target image is too small

- **Iris control**

System defaults Auto Iris. Camera can rapidly adjust size of Iris, through the automatically induct the changing of environment ray, and thus make the brightness of deferent image stable.

User may adjust Iris by controller keyboard “open/close” to get required brightness that you need. User also can resume auto Iris by joystick operation. When controlling the Iris manually, the PTZ locks current position you manually controlled; when operating joystick, the PTZ resume auto Iris.

- **Auto back light compensation**

Camera sub-area can carry out auto back light compensation. Under a strong light background, camera will auto compensate light for the darker object and adjust daylight to the bright background. In order to avoid making the image lack fidelity by the back line is too bright, and the object is unable to recognize because of darkness, thus gain legible image.

- **Auto white balance**

Camera can automatically adjust white balance in accordance with the alteration of background lightness to reach a true colour.

### 3. 4 Monitor function

- **Set and call preset**

Preset function is that PTZ stores current pan/tilt angle, zoom and other position parameters into the memory. When necessary PTZ recalls these parameters and adjust camera to that position. User can store and recall presets easily and promptly by using keyboard controlling. The PTZ can store up to 128 presets.

- **Tour**

Auto tour is the built-in function in the PTZ, to make preset arranged in needful order in tour queue by programming in advance. To make camera tour between presets by inserting presets in cruise tour. It is feasible to program tour order, each time as you run tour, you can set the park time of preset. A tour can store 16 presets.

### **Ø Scan**

The operator can prompt set right limit and left limit in advance by keyboard and menu, so as to make the camera repeatedly scanned between right and left limit at a setting speed.

### **Ø Pattern**

Pattern is built-in function in camera; the PTZ can record tracks that are no less than 180s, when running pattern, the PTZ moves repeatedly according to the recorded tracks. A PTZ can set up to 4 pattern tours.

### **Ø Alarm input/output controlling function**

The PTZ receive an external alarm message, to implement the action that you preset, till the alarm release to resume, if abnormality, it will send another alarm message. The PTZ can set up to 7 alarm input and 2 alarm output.

### **Ø Privacy zone masking**

The user can set a black shadow to mask the area so that it will not appear on the monitor to protect privacy. ( This function is relative with the type of the PTZ, if zoom camera hasn't this function, it is invalid).

### **Ø Lens position display**

The position that the PTZ has finished to auto-checking as 0 point of pan movement and tilt movement. The pan range is 0-360° , and tilt range is 0° ~ +105° . According to the displayed information, to set the position of camera lens, and the position can display on the screen.

## 4. System setting

### 4.1 Basic operation

#### 4.1.1 Current-carrying to PTZ and Self-testing

The PTZ conducts self-testing after current-carrying, and it rotates slowly until displaying pan origin that is default setting, then moving to tilt origin, the lens is adjusted from far zoom to near zoom, then from near zoom to far zoom, when self-testing is finished, there is relevant system information displaying on the screen, as follow:

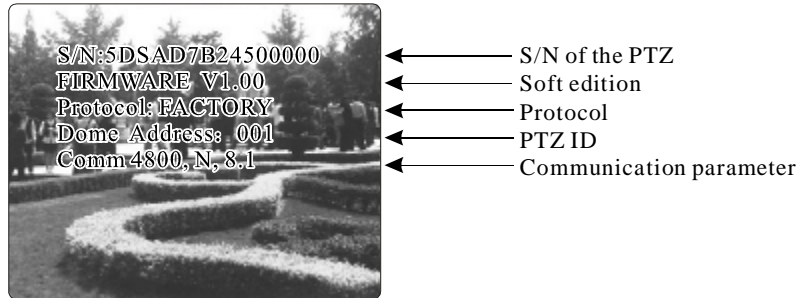

The information will not disappear until you stop to operate the system. If you set “power up action”, the PTZ will automatically activate motions after self-testing. How to operate the function? We will explain detail introduction in following passages.

#### 4.1.2 Call the main menu

The system enters into the main menu by calling 95 preset or by calling 9 preset twice within 3 seconds. All the menu setting must enter into the main menu at first.

#### 4.1.3 Menu and keyboard operation

##### Ø Keyboard operation:

【OPEN】 when choosing pictures, it means to increase Iris; when setting menu, it means to enter into the next menu or setting, or means to save after setting.

【CLOSE】 when choosing pictures, it means to reduce Iris; when setting menu, it means to exit without saving setting.

【NEAR】 Focus to near

【TELE】 Increase magnification

【WIDE】 Reduce magnification

Joystick to up: When choosing menu, it means to choose the former one; when choosing picture, it means camera tilt up.

Joystick to down: when choosing menu, it means to choose the next one; when choosing picture, it means camera tilt down.

Joystick to left: when choosing menu, it is equal with 【CLOSE】, when choosing picture, it means camera tilt left.

Joystick to right: when choosing menu, it is equal with 【OPEN】, when choosing picture, it means camera tilt right.

Press 【TELE】 and 【WIDE】 at the same time, it means 3D joystick rotates joystick cap.

##### Ø Menu operation

“BACK” : Back to the former menu

“EXIT” : Exit to menu

“ON” : Open some setting

“OFF ” : Close some setting

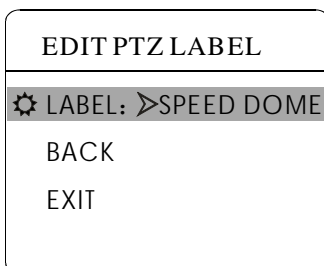
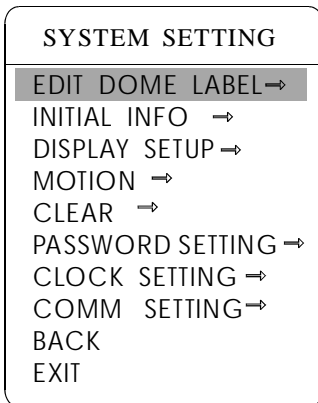
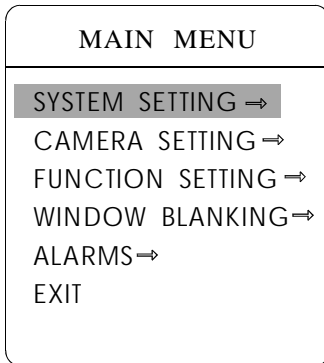

## 4. 2 Edit dome label

When using a lot of PTZs' systems, in order to identify each PTZ, the systems support title setting. The setting ways as follow:

- 1、 The system enters into the main menu by calling 95 preset or by calling 9 preset twice within 3 seconds.
- 2、 Moving joystick up and down to move the cursor to **【SYSTEM SETTING】** , and pressing **【OPEN】** to enter into the next menu.
- 3、 Moving joystick up and down to move the cursor to **【EDIT PTZ LABEL】** , and pressing **【OPEN】** to enter into the label setting menu.
- 4、 Moving joystick up/down to move the cursor to **【LABEL】** , and pressing **【OPEN】** to edit current label.
- 5、 When the cursor is twinkling in the first character of the label, to move joystick to choose character, after editing, pressing **【OPEN】** to save.
- 6、 Moving joystick to **【BACK】** and pressing **【OPEN】** to back to the former menu.



### NOTICE

The label may set 16 characters, and doesn't need editing characters. Pressing **【OPEN】** continuously to jump over and using spacebar to replace the deleted characters. When you finish to edit a character, press **【OPEN】** to enter into the next editing character; when you editing the last character, pressing **【OPEN】** to save. Press **【Close】** to exit.

Characters of label available for choosing are as follow: 0-9, A-Z, : < > . , Space.

Other labels' input ways are the same as above.

# System Setting

---

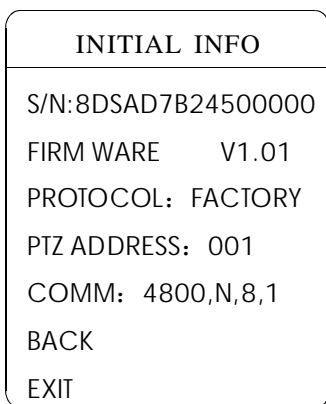
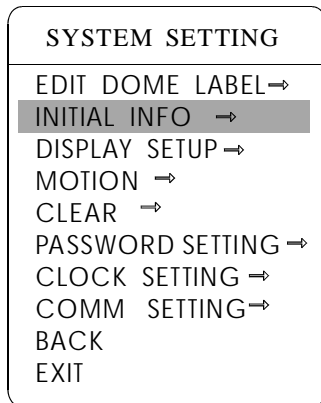
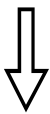
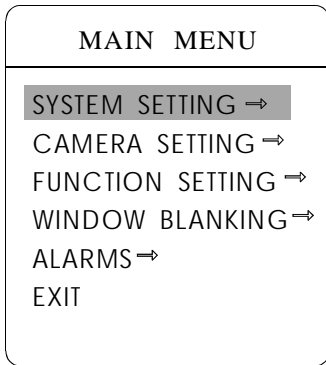

## 4. 3 Display initial information

- 1、 The system enters into the main menu by calling 95 preset or by calling 9 preset twice within 3 seconds.
- 2、 Tilt up/down joystick to **【SYSTEM SETTING】** , press **【OPEN】** to enter submenu.
- 3、 Tilt up/down joystick to **【INITIAL INFO】** , press **【OPEN】** to display initial information as below the left picture .

Initial information includes S/N of the PTZ, soft edition, Protocol, PTZ ID, communication parameter. System setting may change the numerical value of initial information.

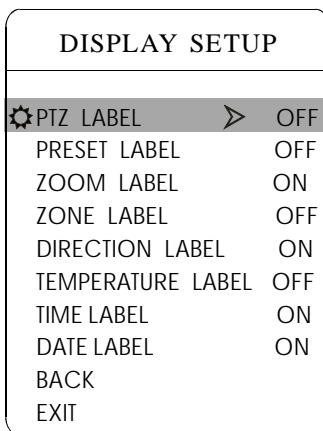
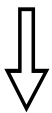
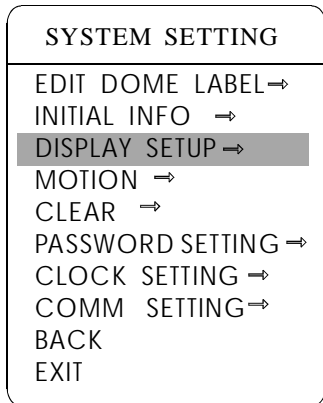
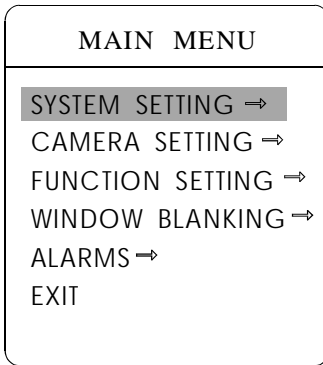

## 4. 4 Display setup

1、The system enters into the main menu by calling 95 preset or by calling 9 preset twice within 3 seconds.

2、Tilt up/down joystick to **【SYSTEM SETTING】** , press **【OPEN】** to enter submenu.

3、Tilt up/down joystick to **【DISPLAY SETUP】** , press **【OPEN】** to enter “display setup” menu, May setting the content of the display setup as follow:

- **【DOME LABEL】**
- **【PRESET LABEL】**
- **【ZOOM LABEL】**
- **【ZONE LABEL】**
- **【DIRECTION LABEL】**
- **【TEMPERATURE LABEL】**
- **【TIME LABEL】**
- **【DATE LABEL】**

4、Taking display PTZ label as an example to explain the operation process. Tilt up/down joystick to move cursor to **【Dome LABEL OFF】** , press **【OPEN】** , there is a sign “⚙️” besides **【Dome LABEL】** , the cursor is twinkling besides **【OFF】** , as left picture shows;

5、Joystick tilt up/down, setting number changes between ON/OFF, when setting **【ON】** , it means to display “PTZ label” ;when setting **【OFF】** , it means not to display “PTZ label” .when pressing **【OPEN】** , the cursor jump back in front of **【DOME LABEL】** , means label setting is finished, when moving the cursor to **【EXIT】** , it means exiting the menu setting.

The displaying information on the screen will change with the PTZ rotation; Through the information on the screen, user can see current PTZ inside temperature, magnification, display zone etc. When all the label are displayed, the PTZ works as the following picture shows, (In the picture “305” means pan angle, “45” means tilt angle. )

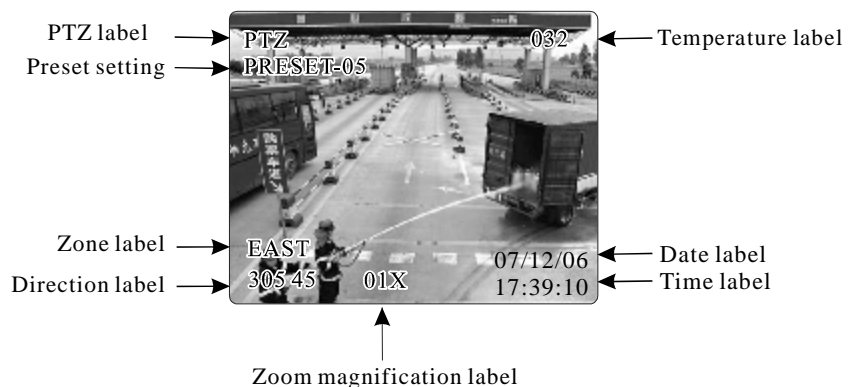

# System Setting

MAIN MENU	
SYSTEM SETTING →	
CAMERA SETTING →	
FUNCTION SETTING →	
WINDOW BLANKING →	
ALARMS →	
EXIT	

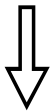

SYSTEM SETTING	
EDIT DOME LABEL →	
INITIAL INFO →	
DISPLAY SETUP →	
MOTION →	
CLEAR →	
PASSWORD SETTING →	
CLOCK SETTING →	
COMM SETTING →	
BACK	
EXIT	

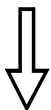

MOTION	
AUTO FLIP	ON
⚙️ PROPORTION PAN	ON
PARK TIME	005
PARK ACTION	SCAN
POWER UP ACTION	AUTO
FAN ENABLED	050
TEMP C/F	CENT
ADVANCE SETTING	→
BACK	
EXIT	

## 4. 5 Systematic motion control

Systematic motion controlling may control a series of canonical movement of the PTZ, and play an important role in controlling the PTZ.

1. The system enters into the main menu by calling 95 preset or by calling 9 preset twice within 3 seconds.
2. Tilt up/down joystick to **【SYSTEM SETTING】** , press **【OPEN】** to enter submenu.
3. Tilt up/down joystick to **【MOTION】** , press **【OPEN】** to enter systematic motion controlling menu, as left picture shows.

### 4. 5. 1 Auto flip

1. Operate joystick, move the cursor to **【AUTO FLIP】** : press **【OPEN】** to enter “ auto flip ” setting, tilt up/down joystick, for example: choosing "ON" to open “ auto flip ” ; choosing "OFF" to close “auto flip” . Press **【OPEN】** to save.

**REMARK:** When opening the auto flip function, user holds the joystick in the down position, the camera rotates pan 180 degrees, after the camera rotates tilt up to 180 degrees.

### 4. 5. 2 Speed proportion pan

1. Operate joystick, move the cursor to **【PROPORTIONAL PAN】** ; press **【OPEN】** to enter “ proportion pan” setting, tilt up/down joystick to choose, if choosing **【ON】** , it means to open proportion pan; if choosing **【OFF】** , it means to close proportion pan , press **【OPEN】** to save.

#### OPERATION KNACKS

When manually adjusting, for far focus situation, the PTZ responds at a high-speed so that touching joystick slightly may make picture move rapidly, thus cause the picture to lose. To base on humanized design, the PTZ automatically adjust pan and tilt rotation according to zoom near and far, which make it is convenient to operate manually run after object.

MOTION	
AUTO FLIP	ON
PROPORTION PAN	ON
PARK TIME	005
 PARK ACTION	➤ SCAN
POWER UP ACTION	AUTO
FAN ENABLED	050
TEMP C/F	CENT
ADVANCE SETTING	➔
BACK	
EXIT	

MOTION	
AUTO FLIP	ON
PROPORTION PAN	ON
PARK TIME	005
PARK ACTION	SCAN
 POWER UP ACTION	➤ AUTO
FAN ENABLED	050
TEMP C/F	CENT
ADVANCE SETTING	➔
BACK	
EXIT	

MOTION	
AUTO FLIP	ON
PROPORTION PAN	ON
PARK TIME	005
PARK ACTION	SCAN
POWER UP ACTION	AUTO
 FAN ENABLED	➤ 050
TEMP C/F	CENT
ADVANCE SETTING	➔
BACK	
EXIT	

### 4. 5. 3 Park action

This setting allows the PTZ to run an appointed action after it enters vacancy for a few time (1-240minutes). If default sets as 0, it means not to run this action automatically.

1、 Operate joystick, move the cursor to **【PARK TIME】** , press **【OPEN】** to tilt up/down joystick to set park time, the range is 0-240 (minute), press **【OPEN】** to save. **【PARK ACTON】** is running action at park time, when **【PARK TIME】** sets as 0, this item can't be set.

2、 Operate joystick, move the cursor to **【PARK ACTON】** , press **【OPEN】** there will be a sign  in the front of **【PARK ACTON】** , the cursor jump to right, after tilt up/down joystick to choose “ park action” , there are options for choosing as follow, press **【OPEN】** to save.

- **【NONE】** - (default) none action
- **【PRESET】** -use preset 1-80
- **【SCAN】** -run scan
- **【PAT1】** - run pattern X
- **【TOUR】** - run tour

### 4. 5. 4 Power up action

The PTZ start to run actions after self-testing, if nobody intervenes it , it will repeatedly run this action continuously , if default sets as **【NONE】** .

1. Operate joystick, move the cursor to **【POWER UP ACTION】** : press **【OPEN】** to jump to the following choice, tilt up/down joystick to choose “power up action” , press **【OPEN】** to save.

- **【NONE】** - none action
- **【AUTO】** - the PTZ resumes the primary action and direction before power up.

before power up.

- **【PRESET】** - use preset 1
- **【SCAN】** - run scan
- **【PAT1】** - run pattern
- **【TOUR】** - run tour

### 4. 5. 5 Fan startup by temperature

The temperature of the PTZ will rise when it is in high temperature. The fan will open automatically when the temperature reaches to a very high degree value in order to make sure the stability of the PTZ.

Operate joystick, move the cursor to **【FAN ENABLED】** : press **【OPEN】** , the cursor will skip to the back option. The user can choose the fan to start up temperature, and press **【OPEN】** to save it in actual condition.

The default setting temperature of the fan startup is 50°C. The user also can enter into the fan startup setting to adjust the temperature of fan startup. As picture shows: the temperature range is 0-60°C. **【TEMP】** can switch the temperature between fahrenheit and centigrade.



MOTION	
AUTO FLIP	ON
PROPORTION PAN	ON
PARK TIME	005
PARK ACTION	SCAN1
POWER UP ACTION	AUTO
FAN ENABLED	040
TEMP	CENT
ADVANCE SETTING	→
BACK	
EXIT	



ADVANCE SETTING	
PRESET FREEZE	N/A
DEFOGGER	10
PT SPEED A D J	100
HEAD DOWN	OFF
WIPER	
IR HEADLIGHT	→
BACK	
EXIT	

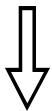

IR HEADLIGHT	
IR HEADLIGHT	MID
DELAY TIME	002
BW	AUTO
ACTIVATE AUX1	OFF
BACK	
EXIT	

## 4.5.6 Advance setting

1. Operate joystick and move to **【ADVANCE SETTING】**, press **【OPEN】** to enter into "advance setting";

**【PRESET FREEZE】** : Function of Preset Freeze means during calling presets, the monitor displays the image before call presets, and releases the freeze image when camera arrives the appointed presets.

**【DEFOGGER】** : Lens of PTZ will be fogged when PTZ works in quite cold temperature. In order to get clear image, defogger will open automatically at the appointed temperature. Choosing **【DEFOGGED】** by operating the joystick, and press **【OPEN】**, then cursor leap to the optional. Choose the temperature to run the defogger, and press **【OPEN】** to save. Range of Temperature: 0~30°C.

**【PT SPEED A D J】** : The rotation percentage of P/T, 100 means factory speed, 80 means 80% of factory speed.

**【HEAD DOWN】** Image inversion **【OFF】** Top mount

**【WIPER】** : Wiper runs by calling 63 Preset.

**【IR HEAD LIGHT】** : Setting of Infrared light. Call 62 preset to run Infrared light under the setting of **【MANUAL】**. Save 62 preset to close the infrared. The default setting of infrared light is Auto MID.

**【Delay time】** : Setting the auto close time of IR light, ranging from 1-240 Minutes.

**【BW】** : Setting the imaging model after the IR light as ON, three modes for choice: Auto, Color, Black.

**【ACTIVATE AUX 1】** Whether to link AUX 1 when open the IR light, "On" means Link. "OFF" means not to link.

### OPERATION KNACKS

1. After the PTZ set the EIS function, if the PTZ wobble slight when running, the camera will shield the wobble picture and make the picture calm and smooth.
2. When start-up preset freeze, it can eliminate the sense of flash caused by calling presets when open function of Preset Freeze, which can reduce the storage space of DVR if image is stored by DVR.



**NOTICE**

These function in the advance setting menu depends on the models and parameters of built-in camera in PTZ, if the camera haven't this function, then this function is invalid. The option is useless (N/A) when the camera module has no such function.

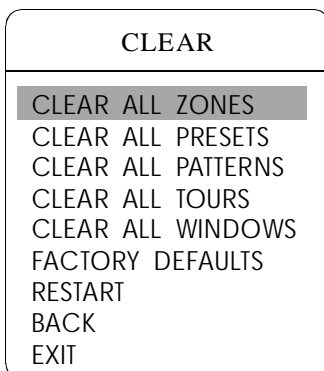
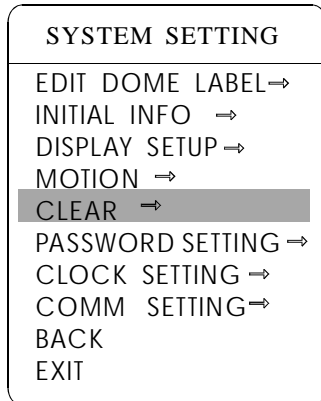
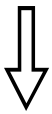
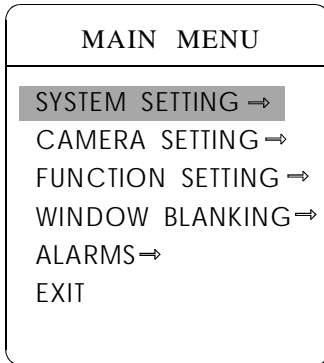

## 4. 6 Clear and restart

1. The system enters into the main menu by calling 95 preset or by calling 9 preset twice within 3 seconds.
2. Tilt up/down joystick to **【SYSTEM SETTING】**, press **【OPEN】** to enter submenu.
3. Tilt up/down joystick to **【CLEAR】**, press **【OPEN】** to enter submenu, as left picture shows.
  - **【CLEAR ALL ZONES】**
  - **【CLEAR ALL PRESETS】**
  - **【CLEAR ALL PATTERNS】**
  - **【CLEAR ALL TOURS】**
  - **【CLEAR ALL WINDOWS】**
  - **【FACTORY DEFAULTS】**: resume the factory default. Run this function, the camera parameter and system parameter will resume to factory default, clear all windows and alarm setting. Please be cautious to use this function.
  - **【RESTART】**
4. Set clear zone as an example to explain the process. Tilt up/down joystick to **【CLEAR ALL ZONES】**, press **【OPEN】** to clear all zones.



### NOTICE

Once clear all commands in the controlling menu, it can't resume, so please be careful of using it.

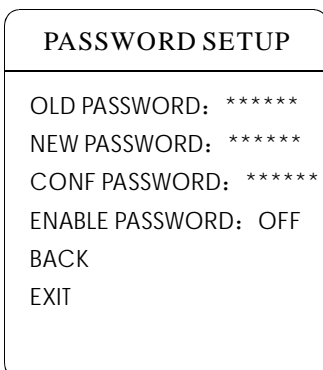
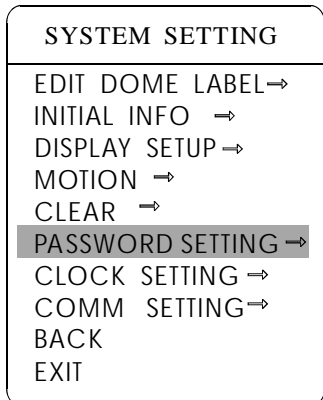
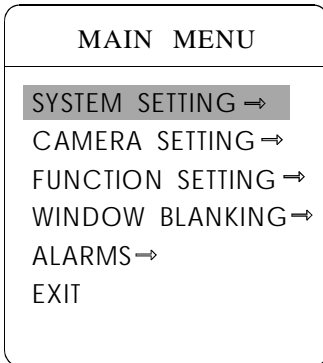

## 4. 7 Password set

1. The system enters into the main menu by calling 95 preset or by calling 9 preset twice within 3 seconds.

2. Operate the joystick up and down, move the cursor to **【SYSTEM SETTING】** , press **【OPEN】** to call the submenu.

3. Operate the joystick up and down , move the cursor to **【PASSWORD SETUP】** , press **【OPEN】** to call the submenu. Please refer to the left picture.

4. Operate the joystick up and down , move the cursor to **【OLD PASSWORD】** , press **【OPEN】** to choose it, operate the joystick right and left to input the password, Tilt up and down to choose the number which you need.

- **【NEW PASSWORD】** Enter the new password
- **【CONFIRM PASSWORD】** Confirm the new password
- **【ENABLE PASSWORD】** Set PASSWORD off / on

(The password function is noneffective under the PASSWORD OFF.) It means that users can enter into the main menu without password. (The password function is effective under the password ON.) It means that user enter into the main menu with password.

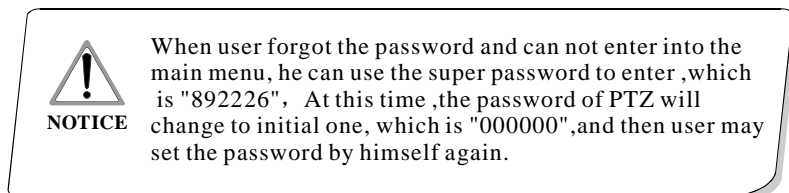

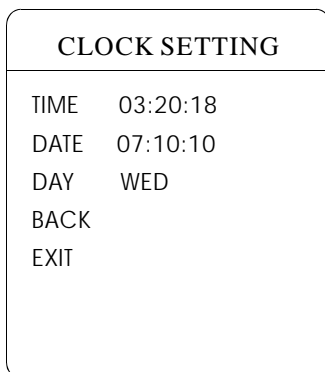
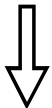
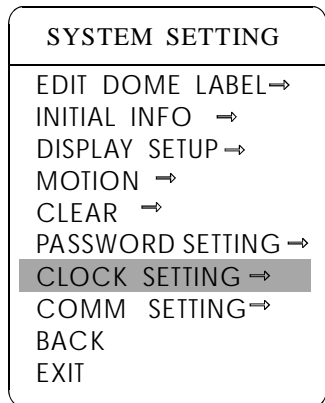
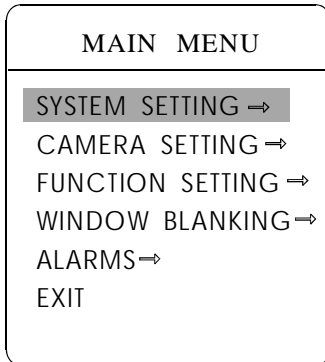

### 4. 8 Time set

1. The system enters into the main menu by calling 95 preset or by calling 9 preset twice within 3 seconds.

2. Operate the joystick up and down, move the cursor to **【SYSTEM SETTING】**, press **【OPEN】** to call the submenu.

3. Operate the joystick up and down, move the cursor to **【CLOCK SETTING】**, press **【OPEN】** to call the submenu. Please refer to the left picture.

4. Operate the joystick up and down, move the cursor to **【TIME】**, press **【OPEN】** to choose it, move the joystick up and down to choose the number you need, move the joystick right and left to set hour, minute, second.

- **【DATE】** set year, month, date;
- **【DAY】** set week;
- **【BACK】** return to the former menu;
- **【EXIT】** exit the main menu.

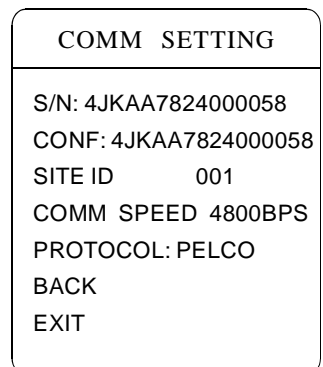
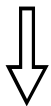
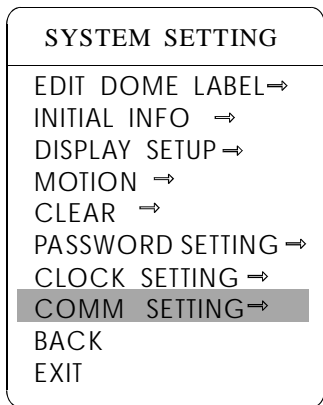
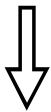
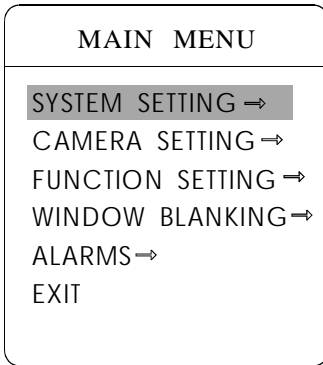

## 4. 9 Setup Dome parameter

- 1.The system enters into the main menu by calling 95 preset or by calling 9 preset twice within 3 seconds.
- 2.Click the up and down button to move the cursor to **【SYSTEM SETTING】**, and click the right button to enter into the next menu.
- 3.Click the up and down button to move the cursor to **【COMM SETTING】**, and clicking the right button to enter into Dome parameter setup menu.

**S/N:** Show Series NO. of the dome ex-work.

**CONF:** Using to edit, the series NO. of the dome is the same as S/N series Number.

**SITE ID:** Setting up the ID Number of the dome, address scope (001-255).  
**COMM SPEED:** Baud rate setup. The user can choose 4 kinds of Baud-rate (2400 BPS, 4800 BPS, 9600 BPS, 19200 BPS).



**Notice:** when you set the **【COMM SETTING】**, all the code switch SW1 and SW2 are set to **【ON】**.

**PROTOCOL:** set protocol, the user can choose 16 kinds of protocol: PELCO, FACTORY, DYNACOLOR, ISD, HUNDA, VIDO B02, LILIN, KALATEL, DIAMOND, SAMSUNG, PANASONIC, SANTACHI, VICON, MOLYNX, VCL, SAE.



**Remark:** below operation can not be continue when above two series Number are not the same.

MAIN MENU	
SYSTEM SETTING →	
<b>CAMERA SETTING →</b>	
FUNCTION SETTING ⇒	
WINDOW BLANKING →	
ALARMS →	
EXIT	



CAMERA SETTING	
<b>ZOOM SPEED</b>	<b>HIGH</b>
DIGITAL ZOOM	OFF
BLC MODE	OFF
SLOW SHUTTER	ON
LINE SYNC	N/A
WDR MODE	OFF
VIDEO MODE	720P/30
ADVANCE SETTING	
BACK	

## 5. Camera setting

### 5.1 Zoom speed

1. The system enters into the main menu by calling 95 preset or by calling 9 preset twice within 3 seconds.
2. Operate joystick and move cursor to **【CAMERA SETTING】** , press **【OPEN】** to enter submenu.
3. Operate joystick and move cursor to **【ZOOM SPEED】** ; press **【OPEN】** "**\***" will appear in the front of **【HIGH】** , the cursor moves to right, tilt up/down joystick to choose **【HIGH】** or **【LOW】** .
4. Press **【OPEN】** to save, press **【CLOSE】** to cancel.

MAIN MENU	
SYSTEM SETTING →	
<b>CAMERA SETTING →</b>	
FUNCTION SETTING →	
WINDOW BLANKING →	
ALARMS →	
EXIT	



CAMERA SETTING	
ZOOM SPEED	HIGH
<b>DIGITAL ZOOM</b>	<b>OFF</b>
BLC MODE	OFF
SLOW SHUTTER	ON
LINE SYNC	N/A
WDR MODE	OFF
VIDEO MODE	720P/30
ADVANCE SETTING	
BACK	

## 5.2 Digital zoom control

1. The system enters into the main menu by calling 95 preset or by calling 9 preset twice within 3 seconds.
2. Operate joystick and move cursor to **【CAMERA SETTING】** , press **【OPEN】** to enter camera setting.
3. Operate joystick, move the cursor to **【DIGITAL ZOOM】** , press **【OPEN】** to enter digital zoom setting, tilt up/down joystick, to choose ON means open digital zoom control which is digital zoom is pulled near, if pulling the digital zoom near again, the dome enters into “ digital zoom increase” ; to choose OFF means to close digital zoom control.
4. Press **【OPEN】** to save.



### OPERATION KNACKS

When digital zoom be set as ON, the maximum zoom magnification of the dome is digital zoom magnification times optical zoom magnification; when digital zoom be set as OFF, the maximum zoom magnification of the dome is optical zoom magnification.

The option of the digital zoom is ON/OFF when the camera module is SONY, LG, CNB, HITACHI .



When shows N/A, it means this camera module does not have this function.

MAIN MENU	
SYSTEM SETTING	⇒
<b>CAMERA SETTING</b>	⇒
FUNCTION SETTING	⇒
WINDOW BLANKING	⇒
ALARMS	⇒
EXIT	



CAMERA SETTING	
ZOOM SPEED	HIGH
DIGITAL ZOOM	OFF
<b>BLC MODE</b>	OFF
SLOW SHUTTER	ON
LINE SYNC	N/A
WDR MODE	OFF
VIDEO MODE	720P/30
ADVANCE SETTING	
BACK	
EXIT	

## 5.3 Back light compensation

1. The system enters into the main menu by calling 95 preset or by calling 9 preset twice within 3 seconds.

2. Operate joystick and move cursor to **【CAMERA SETTING】** to enter submenu.

3. Operate joystick and move cursor to **【BLC MODE】**, press **【OPEN】**, There will be a sign “\*” in the front of **【BLC MODE】**, tilt up/down joystick to open or close back light compensation function. If choosing ON means to open back light compensation mode; if choosing OFF means to close back light compensation mode. Different camera.

4. Press **【OPEN】** to save.



When it shows N/A, it means this camera module does not have this function.



Non-use back light compensation, in strong sunshine, the back light side is subject to dark.

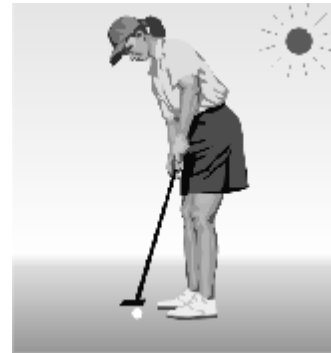

Use back light compensation, the image is in gear.



### OPERATION KNACKS

Strong background ray can make backlighting objects engender shadow, (back light compensation), the speed dome can auto-adjust iris to match with the changes of various ray, and auto-revise the main lightness to make the pictures more legible.



This function relates to models and parameters of the built-in camera in the dome, when open black compensation, it has two functions which are auto-adjust (when you choose ON) or manual adjust(0-255) according to the different of the camera.



MAIN MENU	
SYSTEM SETTING →	
<b>CAMERA SETTING →</b>	
FUNCTION SETTING →	
WINDOW BLANKING →	
ALARMS →	
EXIT	

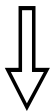

CAMERA SETTING	
ZOOM SPEED	HIGH
DIGITAL ZOOM	OFF
BLC MODE	OFF
<b>SLOW SHUTTER</b>	<b>ON</b>
LINE SYNC	N/A
WDR MODE	OFF
VIDEO MODE	720P/30
ADVANCE SETTING	
BACK	
EXIT	

CAMERA SETTING	
ZOOM SPEED	HIGH
DIGITAL ZOOM	OFF
BLC MODE	OFF
SLOW SHUTTER	ON
<b>LINE SYNC</b>	<b>N/A</b>
WDR MODE	OFF
VIDEO MODE	720P/30
ADVANCE SETTING	
BACK	
EXIT	

## 5.4 Slow shutter control

1. The system enters into the main menu by calling 95 preset or by calling 9 preset twice within 3 seconds.
2. Operate joystick and move cursor to **【CAMERA SETTING】** to enter submenu.
3. Operate joystick and move cursor to **【SLOW SHUTTER】**, press **【OPEN】**, there will be a sign “\*” in the front of **【SLOW SHUTTER】**, tilt up/down joystick to “slow shutter” choice, if choosing ON means to open slow shutter function, if choosing OFF means close “slow shutter” function. Some cameras have more options for light time of slow shutter, from X2-X128.
4. Press **【OPEN】** to save.



### OPERATION KNACKS

When the dome monitors at night or dark environment, because the ray is not enough, the image on the screen is too dark, setting slow shutter can lengthen the time of lighting so that make the picture that is shoot in dark more legible.



This function depends on the models and parameters of built-in camera in dome, if the camera doesn't have this function, then this function is invalid.

## 5.5 Line sync control

1. The system enters into the main menu by calling 95 preset or by calling 9 preset twice within 3 seconds.
2. Operate joystick and move the cursor to **【CAMERA SETTING】**, press **【OPEN】** to enter submenu.
3. Operate joystick and move the cursor to **【LINE SYNC】**; press **【OPEN】**, tilt up/down joystick to set line sync. Line sync can divide two kinds: internal/external, choose OFF is internal sync; choose ON is external sync.
4. Press **【OPEN】** to save.



### OPERATION KNACKS

When a lot of domes use a line in the same time, if the image is twinkling as switching, please set each dome as external line and adjust the numerical value of external line.



This function is relative with the model and parameter of the camera module which insert in the dome. The option is useless(N/A) when the camera module does not have this function.

MAIN MENU	
SYSTEM SETTING →	
CAMERA SETTING →	
FUNCTION SETTING →	
WINDOW BLANKING →	
ALARMS →	
EXIT	

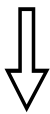

CAMERA SETTING	
ZOOM SPEED	HIGH
DIGITAL ZOOM	OFF
BLC MODE	OFF
SLOW SHUTTER	ON
LINE SYNC	N/A
WDR MODE	OFF
VIDEO MODE	720P/30
ADVANCE SETTING	
BACK	
EXIT	

CAMERA SETTING	
ZOOM SPEED	HIGH
DIGITAL ZOOM	OFF
BLC MODE	OFF
SLOW SHUTTER	ON
LINE SYNC	N/A
WDR MODE	OFF
VIDEO MODE	720P/30
ADVANCE SETTING	
BACK	
EXIT	

## 5.6 WDR Control

1. The system enters into the main menu by calling 95 preset or by calling 9 preset twice within 3 seconds.
2. Operate joystick and move the cursor to **【CAMERA SETTING】** , press **【OPEN】** , Enter the next main menu
3. operate joystick and move the cursor to **【WDR MODE】** , press **【OPEN】** , tilt up/down joystick to set WDR. Choice ON is open WDR Function, choice off is closed WDR, if you choice Auto, Than mean Auto setting WDR.
4. Press **【OPEN】** to save.



This function is relative with the model and parameter of the camera module which insert in the dome. The option is useless(N/A)when the camera module does not have this function.

## 5.7 Video Output Setting

1. The system enters into the main menu by calling 95 preset or by calling 9 preset twice within 3 seconds.
2. Operate joystick and move the cursor to **【CAMERA SETTING】** , press **【OPEN】** , Enter the next main menu
3. Operate joystick and move the cursor to **【VIDEO MODE】** ,press **【OPEN】** , tilt up/down joystick Set the video output format Image input format, Range:1080P/30, 1080P/25, 720P/60, 720P/50, 720P/30, 720P/25.

video output shortcut: call the following presets twice within 3 seconds

241+PRESET=720P/60	243+PRESET=720P/50
244+PRESET=1080P/30	245+PRESET=1080P/25
246+PRESET=720P/30	247+PRESET=720P/25

It will be valid after restart.

MAIN MENU	
SYSTEM SETTING →	
<b>CAMERA SETTING →</b>	
FUNCTION SETTING →	
WINDOW BLANKING →	
ALARMS →	
EXIT	



CAMERA SETTING	
ZOOM SPEED	HIGH
DIGITAL ZOOM	OFF
BLC MODE	OFF
SLOW SHUTTER	ON
LINE SYNC	N/A
WDR MODE	N/A
VIDEO MODE	720P/30
<b>ADVANCE SETTING</b>	
BACK	
EXIT	



ADVANCE SETTING	
<b>DAY/NIGHT</b>	<b>SETTING</b>
EXPOSURE	
COLOR	
PICTURE	
FOCUS	
BACK	
EXIT	



DAY/NIGHT SETTING	
DAY/NIGHT	AUTO
BLACK TIME	N/A
COLOR TIME	N/A
THRESHOLD	10dB
AGC LIMIT	28dB
BACK	
NEXT	

## 5.8 Advance setting

1. The system enters into the main menu by calling 95 preset or by calling 9 preset twice within 3 seconds.
2. Operate joystick and move the cursor to **【CAMERA SETTING】** , press **【OPEN】** , Enter the next main menu
3. Operate joystick and move the cursor to **【ADVANCE SETTING】** ; press **【OPEN】** to enter submenu, as left picture shows;

### 5.8.1 DAY/NIGHT mode

1. Operate joystick and move the cursor to **【DAY/NIGHT】** , press **【OPEN】** , tilt up/down joystick to choose AE mode, modes for choosing as follow:

- **【DAY/NIGHT】**
- **【BLACK TIME】**
- **【COLOR TIME】**
- **【THRESHOLD】** : sensitivity of switch between B/W and color.

The higher numerical value means lower sensitivity and longer switch time. In contrast, the lower numerical value means higher sensitivity and shorter switch time (Range: 8-28 dB)

- **【AGC LIMIT】** Automatic gain selection range 8-28Db when the darker **【AGC LIMIT】** value is smaller the image snow point is less **【AGC LIMIT】** value is great the image snow point is more

2. Press **【OPEN】** to save.



#### OPERATION KNACKS

IR cut filter function uses color in day; use black and white at night. This function not only guarantees the quality of image, but also saves the room of storage.



This function depends on the models and parameters of built-in camera in dome, if the camera doesn't have this function, then it is invalid(N/A).

CAMERA SETTING	
ZOOM SPEED	HIGH
DIGITAL ZOOM	OFF
BLC MODE	OFF
SLOW SHUTTER	ON
LINE SYNC	N/A
WDR MODE	N/A
VIDEO MODE	720P/30
ADVANCE SETTING	
BACK	
EXIT	



ADVANCE SETTING	
DAY/NIGHT	SETTING
EXPOSURE	
COLOR	
PICTURE	
FOCUS	
BACK	
EXIT	



EXPOSURE	
AE MODE	AUTO
SHUTTER	N/A
IRIS	N/A
BRIGHT	N/A
EXPOS.COMP	OFF
BACK	
NEXT	

COLOR	
WB MODE	AUTO
R GAIN	N/A
B GAIN	N/A
COLOR GAIN	120
COLOR HUE	0
BACK	
NEXT	

## 5. 8. 2 AE mode

- 1、Operate joystick, move the cursor to **【EXPOSURE】**, press **【OPEN】**, tilt up/down joystick to choose AE mode, modes for choosing as follow:
  - **【AUTO】** : default setting, auto Iris mode
  - **【BRIGHT】** : brightness priority mode
  - **【IRIS】** : iris priority mode
  - **【SHUTTER】** : shutter priority mode
  - **【MANUAL】** : override
- 2、Choose Iris priority mode **【IRIS】**, press **【OPEN】** to save.
- 3、Move joystick to the sub-choices of AE mode **【IRIS F1.4】**, press **【OPEN】** to choose adequate Iris, press **【OPEN】** to save.
  - **【SHUTTER 1/50】** it means shutter speed, when AE mode is shutter priority, this function can be set.
  - **【IRIS F1.4】** it means the size of iris, when AE mode is iris priority, this function can be set.
  - **【BRIGHT F2.0/ODB】** it means brightness, when AE mode is brightness priority, this function can be set.
  - **【EXPOS.COMP】** exposure compensation

## 5. 8. 3 White balance mode

- 1、Operate joystick, move the cursor to **【WB MODE】** to choose white balance mode, press **【OPEN】** to save.

Auto mode **【AUTO】** is the default mode of speed PTZ, which is auto-revert real color after the white balance sensor check the environment by camera. When choosing manual mode **【MANUAL】**, adjust the numerical value of **【R GAIN】** and **【B GAIN】**.

- **【R GAIN】** the range is 1-225; the numerical value is bigger, it means that adding red is more, the tone changes to be warm.
- **【B GAIN】** the range is 1-225; the numerical value is bigger, it means that adding green is more, the tone changes to be cold.
- **【COLOR GAIN】** color gain setting
- **【COLOR HUE】** color chroma setting



This function depends on the models and parameters of built-in camera in dome, if the camera doesn't have this function, then it is invalid(N/A).

CAMERA SETTING	
ZOOM SPEED	HIGH
DIGITAL ZOOM	OFF
BLC MODE	OFF
SLOW SHUTTER	ON
LINE SYNC	N/A
WDR MODE	N/A
VIDEO MODE	720P/30
ADVANCE SETTING	
BACK	
EXIT	



ADVANCE SETTING	
DAY/NIGHT	SETTING
EXPOSURE	
COLOR	
PICTURE	
FOCUS	
BACK	
EXIT	



PICTURE	
GAMMA	000
SHARPNESS	10
MIRROR	OFF
FLIP	OFF
HI-RESOLUTION	OFF
NOISE REDUCT	0
IMAGE STABLE	N/A
BACK	
NEXT	

FOCUS	
AUTO FOCUS	ON
FOCUS OFFSET	000
BACK	
NEXT	

## 5.8.4 Image Setting Function

1. Operate the joystick to move the cursor to **【PICTURE】**, move joystick rightward or press **【OPEN】** to enter the submenu;

**【GAMMA】** gamma correction

**【SHARPNESS】** sharpness setting

**【MIRROR】** mirror image

**【FLIP】** 180° image slip function

**【HI-RESOLUTION】** build-in hi-resolution function, depend on the type of the camera module

**【NOISE REDUCE】** Image de noising

**【IMAGE STABLE N/A】** Image enhancement

2. Press **【OPEN】** to save the setting.

## 5.8.5 Focus

1. Operate the joystick to move the cursor to **【FOCUS】**, move joystick rightward or press **【OPEN】** to enter the submenu;

● **【FOCUS OFFSET】** Adjust the focus center, to eliminate the negative effect on focus owing to the PMMA dome cover

2. Press **【OPEN】** to save the setting.

● **【FOCUS MODE】**

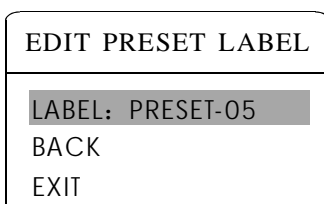
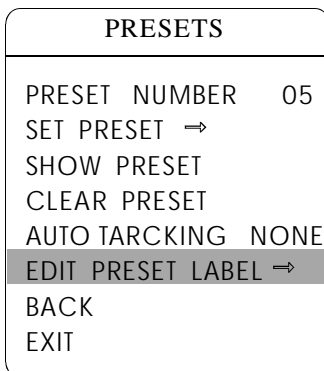
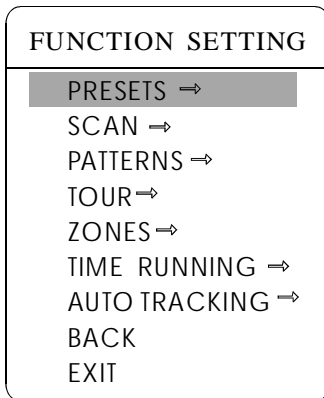
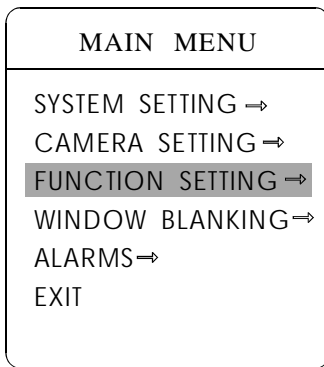

## 6. Function setting

### 6. 1 Preset

1. The system enters into the main menu by calling 95 preset or by calling 9 preset twice within 3 seconds. Click each command to enter “preset menu” according to the order of the left picture. As follows:

- **【PRESET NUMBER】**
- **【SET PRESET】**
- **【SHOW PRESET】**
- **【CLEAR PRESET】**
- **【AUTO TRACKING】** (If the dome does not have this function, it won t display )
- **【EDIT PRESET LABEL】**

Define preset and call preset function can be set by keyboard operation, input preset number at first, then click the key “save /call preset” to carry out.

2. Define current preset number: move the cursor to **【PRESET NUMBER】** , press **【OPEN】** to choose preset number, the range is 1-128 as the left picture shows, here chooses number 5 as current preset, the following operations aim at the current preset.

3. Define current preset: move the cursor to **【SET PRESET】** ,press **【OPEN】** , by operating joystick to adjust magnification, to choose good objective image, press **【OPEN】** to save. If the image is very near, the Image is belong in digital zoom. When setting preset, the image will jump to maximal optical zoom.

#### OPERATION KNACKS

Preset function is that dome stores current pan/tilt angle, zoom and other position parameters into the memory. When necessary,dome recalls these parameters and adjust camera to that position.

4. Display current preset: move the cursor to **【SHOW PRESET】** , press **【OPEN】** , the screen will display the current preset;

5. Clear current preset: move the cursor to **【CLEAR PRESET】** , press **【OPEN】** , the current preset is cleared.

6. **【AUTO TRACKING】** : Call preset to Set auto-tracking ON/OFF; set as ON, call the current preset to open auto-tracking function; set as OFF, call the current preset to close auto-tracking function; Set as NONE, call the current preset has no effect in auto-tracking function.

7. Edit current preset label: move the cursor to **【EDIT PRESET LABEL】** , press **【OPEN】** to enter into editing preset submenu, system auto-sets label as PRESET-XX, press **【OPEN】** to revise label.

1. When running to program, display, clear preset and edit label, should choose preset number at first.
2. The label may set up to 16 characters, and doesn't need editing characters. Press **【OPEN】** continuously to jump over and use spacebar to replace the deleted characters. When you finish to edit a character, press **【OPEN】** to enter into the next editing character; when you finish to edit the last character, pressing **【OPEN】** to save. Press **【CLOSE】** to exit. Character of label is suitable for choosing as follow: 0-9, A-Z, :<>-. , space.
3. As the submenu **【STATE】** in **【AUTO TRACKING】** is set as OFF, it is valid to Call preset to set auto-tracking ON/OFF.



**NOTICE**

(Pls refer to the Paragraph 6.7)

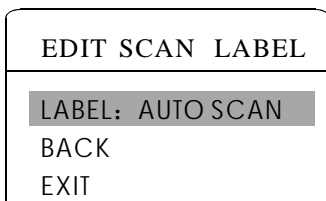
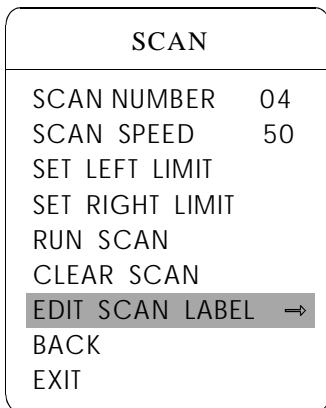
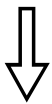
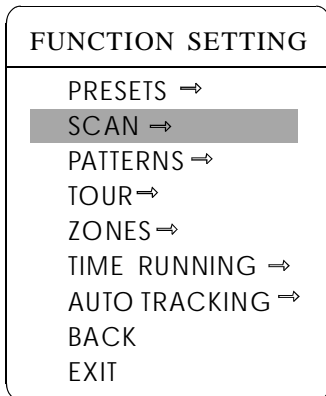
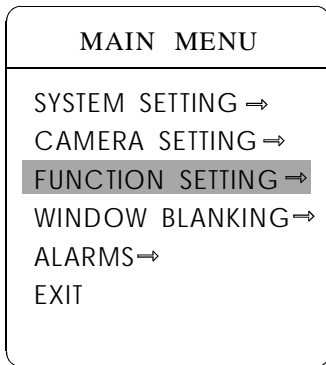

## 6. 2 Scan

Scan is that preset two points , then the camera repeatedly scan between the two points at a stable speed, the same magnification and pan. A dome has four scan tour.

1、 The system enters into the main menu by calling 95 preset or by calling 9 preset twice within 3 seconds. click menu to enter “scan” menu, as the left picture shows.

- **【SCAN NUMBER】**
- **【SCAN SPEED】**
- **【SET LEFT LIMIT】**
- **【SET RIGHT LIMIT】**
- **【RUN SCAN】**
- **【CLEAR SCAN】**
- **【EDIT SCAN LABEL】**

2、 Define current scan number: operate joystick ,move the cursor to **【SCAN NUMBER】** ,press **【OPEN】** ,tilt up/downjoystick to choose scan number, press **【OPEN】** to save .the following operations aim at the current scan number.

3、 Scan speed setting: operate joystick to **【SCAN SPEED】** , press **【OPEN】** , tilt up/down joystick to adjust scan speed, press **【OPEN】** to save.

4、 Left limit setting: operate joystick to **【SET LEFT LIMIT】** , press **【OPEN】** , operate joystick to choose objective image, press **【OPEN】** to save. Right limit setting is the same as left limit setting

5、 Edit scan label: operate joystick, move the cursor to **【EDIT SCAN LABEL】** ,press **【OPEN】** to enter submenu “ edit label” , move the cursor to **【LABEL】** , the system will auto-set the label as AUTO SCAN, press **【OPEN】** to revise.

The label can set up to 16 characters, and doesn't need editing characters. Pressing **【OPEN】** continuously to jump over and using spacebar to replace the deleted characters. When you finish to edit a character, pressing **【OPEN】** to enter into the next editing character when you finish to edit the last character, pressing **【OPEN】** to save.



**NOTICE**

Press **【CLOSE】** to exit.

Character of label is suitable for choosing as follow: 0-9、 A-Z、 : <>-. , Space. The editing ways of other labels are the same as above.

6、 Run scan: operate joystick to **【RUN SCAN】** , press **【OPEN】** to exit the menu, and it starts to run scan.



**NOTICE**

1. left limit and right limit of scan can't be set the same point.
2. Under scan process, speed, magnification and tilt direction won't change, if the speed, magnification and tilt direction of the two limits are inconsistent, run scan is base on left limit.

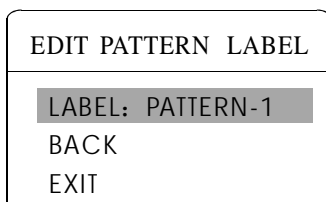
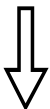
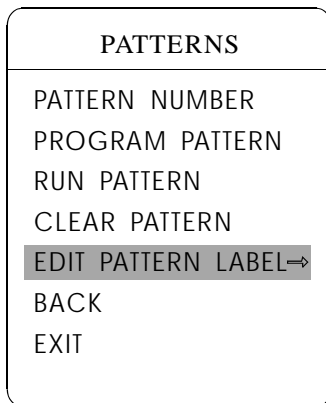
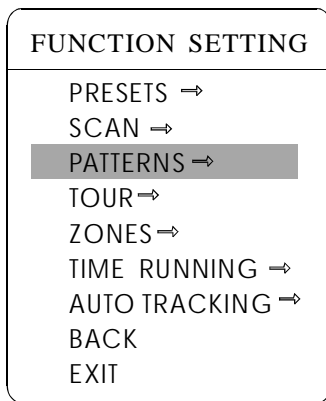
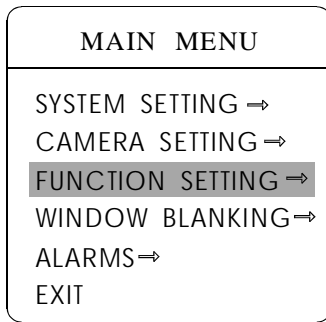

### 6.3 Pattern

Pattern is built-in function in camera; the PTZ can record tracks that are no less than 180s. (A series of pan/tilt controlling and lens controlling command). A PTZ may set up to 4 pattern tours.

1、 The system enters into the main menu by calling 95 preset or by calling 9 preset twice within 3 seconds.

2、 Operate joystick, move the cursor to **【FUNCTION SETTING】**, press **【OPEN】** to enter submenu.

3、 Operate joystick to **【PATTERN】**, press **【OPEN】** to enter menu “Pattern”.

- **【PATTERN NUMBER】**
- **【PROGRAM PATTERN】**
- **【RUN PATTERN】**
- **【CLEAR PATTERN】**
- **【EDIT PATTERN LABEL】**

4、 Choose pattern number: move the cursor to **【PATTERN NUMBER】**, press **【OPEN】**, pattern you choose as current pattern, the following operations aim at the current pattern;

5、 Define current pattern tour: move the cursor to **【PROGRAM PATTERN】**, press **【OPEN】** to set pattern track, move the image random, and draw the focus. The PTZ has a tour that is no less than 180s, a series of park time, magnification, focus will be recorded, press **【OPEN】** to save.

6、 Run pattern: operate joystick to **【RUN PATTERN】**, press **【OPEN】** to run, the PTZ will continuously and repeatedly record the specific track.



**NOTICE**

When carry out program, run, clear pattern and edit label, should choose pattern number at first.



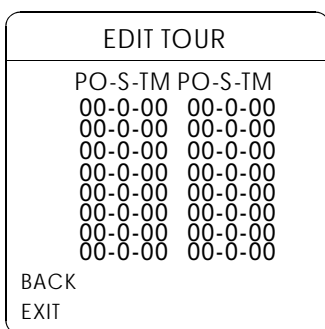
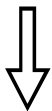
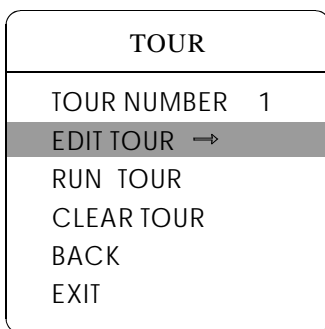
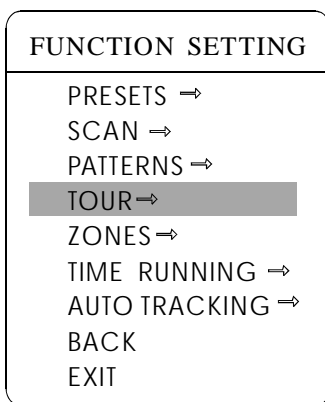
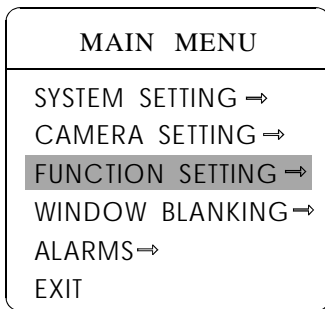

## 6. 4 Tour

Tour is the built-in function in the PTZ, it will arrange the presets into the queue of auto-tour, and can set how long it will park at preset. Operate auto-tour is a process of incessantly transfer each preset. One tour can store 16 presets at most.

1、 The system enters into the main menu by calling 95 preset or by calling 9 preset twice within 3 seconds.

2、 Operate joystick, move the cursor to **【FUNCTION SETTING】** , press **【OPEN】** enter submenu.

3、 Operate joystick, move the cursor to **【TOUR】** , press **【OPEN】** to enter menu “tour” ;

4、 Set the park time of preset: Operate joystick, move the cursor to **【TOUR DWELL】** , press **【OPEN】** , there will be a sign ⚙ in the front of **【TOUR DWELL】** , the cursor jumps to right, tilt up/down to set park time, and the range is 000-255(s)

5、 Set tour :move the cursor to **【EDIT TOUR】** ,press **【OPEN】** to set tour interface, **【PO-S-TM】** set preset ,speed and time ,press **【OPEN】** , the first dwell is activated , tilt up/down joystick to choose preset number, the preset numerical value should be within 1-80 preset , a tour can set up to 24 presets .press **【OPEN】** ,the cursor jump to the next dwell ,tilt up/down joystick to choose current arrival preset speed , total 8 level of speed ,increasingly from level 1 to level 8;Press **【OPEN】** ,the cursor jumps to the next dwell , tilt up/down joystick to set current preset maintaining time,60 seconds maximum . If set the presets of the second line ,move the cursor to the second line , press **【OPEN】** to continue edit .press **【OPEN】** to save after setting ,press **【CLOSE】** to exit.

6、 Run tour: Operate joystick, move the cursor to **【RUN TOUR】** , press **【OPEN】** to exit the menu, it starts to run tour.



**NOTICE**

the system will leap over the preset automatically when the stay time of one item setting up on 0; The PTZ will not run the tour of latter preset when preset or movement speed setting up on 0 .

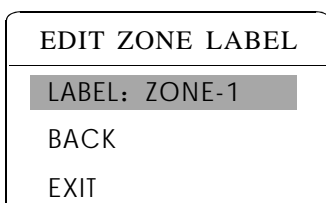
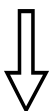
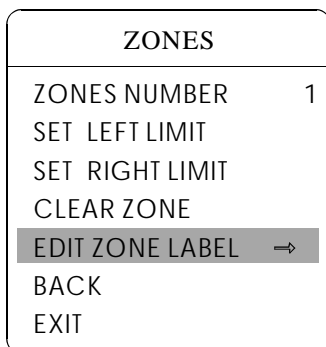
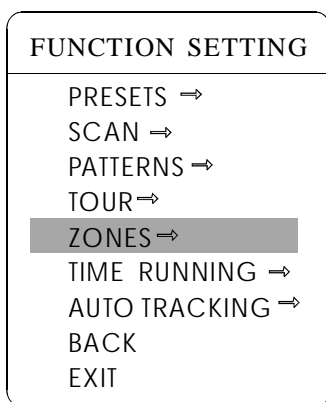
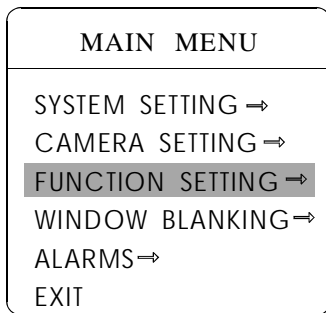

### 6.5 Zone

A PTZ may be set up to 8 zones; the regional scene can't be overlapped. User can set label for each zone. When setting **【ZONE LABEL】** as ON, the PTZ will display zone label as it runs some zone. It is convenient to know the zone that the camera shoots by setting zone label.

- 1、The system enters into the main menu by calling 95 preset or by calling 9 preset twice within 3 seconds.
- 2、Operate the joystick, move the cursor to **【FUNCTION SETTING】**, press **【OPEN】** to enter submenu.
- 3、Operate the joystick, move the cursor to **【ZONES】**, press **【OPEN】** to enter submenu, as the left picture shows.

- **【ZONES NUMBER】**
- **【SET LEFT LIMIT】**
- **【SET RIGHT LIMIT】**
- **【CLEAR ZONE】**
- **【EDIT ZONE LABEL】**

Regard the left/right limit as the demarcation line, and set the middle part as a zone. Various operational ways are the same as other settings in the menu. Therefore we won't explain it again.

MAIN MENU	
SYSTEM SETTING →	
CAMERA SETTING →	
<b>FUNCTION SETTING →</b>	
WINDOW BLANKING →	
ALARMS →	
EXIT	



FUNCTION SETTING	
PRESETS →	
SCAN →	
PATTERNS →	
TOUR →	
ZONES →	
<b>TIME RUNNING →</b>	
AUTO TRACKING →	
BACK	
EXIT	

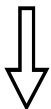

TIME RUNNING	
DAY	SAT
TIME CHANNEL	1
START TIME	00:00
END TIME	00:00
RUNNING	TOUR1
BACK	
EXIT	

## 6.6 Time running

User can set the time of preset, scan, tour and pattern.

1. Call 95 preset or call 9 preset twice within 3 seconds to enter into the main menu.
2. Operate the joystick, move the cursor to **【FUNCTION SETTING】** , press **【OPEN】** to call the submenu.
3. Operate the joystick, move the cursor to **【TIME RUNNING】** , press **【OPEN】** to enter into the menu setting. Please refer to the left picture.

**【DAY】** set the date

**【TIME CHANNEL】** 4 channels can be set.

**【START TIME】** Set the start time

**【END TIME】** Set the end time

**【RUNNING】** User can set the preset , scan , tour, pattern to every channel.(1-4)

4. This channel will not conflict with other channels when you set **【RUNNING】** as close.

1. When user do the action of scan, tour or pattern, if time is over, then the PTZ will execute park action, the user's action will stop. After the time, the PTZ will resume the action and preset which is set before the park time. (Before the park time, if the PTZ is on some preset, the PTZ will resume the preset, if PTZs execute the action of scanning, tour or pattern, the PTZ will resume original action. If users handle some action with keyboard, PTZ will also resume the action which users are going on with keyboard.)



**NOTICE**

2. During the timing period of movement function, it is not allowed that there is no action. When users handle the PTZ, the timing movement function will interrupt. If there is no any action during 30 seconds, it will be in the state of timing function, and return to the timing movement function. Or if there is idle function, it will be do the action of idle time function.

3. Timing function will close while user setting presets, right and left limit, menu status, recording scan and setting any other function.

4. When the PTZ execute alarm, timing, idle function, the priority for alarm is the highest, for timing is the second, for idle is the lowest.

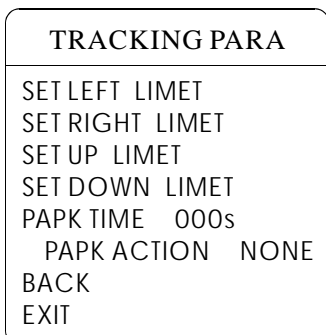
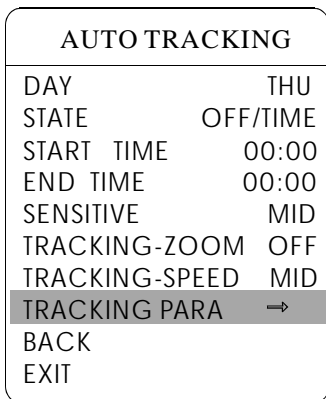
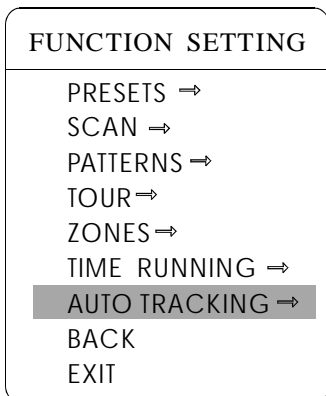
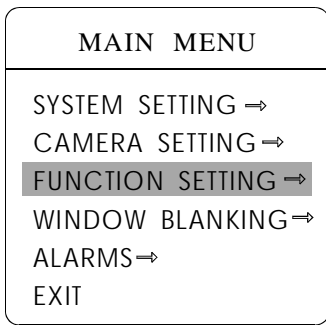

## 6.7 Set auto-tracking

When initiate Auto tracking function, the speed dome automatically captures the picture of the moving object, thus real-timely tracking.

1.Call 95 preset or call 9 preset twice within 3 seconds, input password to enter the main menu.

2.Operate the joystick to move the cursor to **【FUNCTION SETTING】**, press **【OPEN】** to enter the next menu.

3.Operate the joystick to move the cursor to **【AUTO TRACKING】**, press **【OPEN】** to enter the next menu, as showed on the left picture.

4. Set left limit of the motion detection area: operate the joystick to **【SET LEFT LIMIT】**, press **【OPEN】**, operate joystick to the target position, then press **【OPEN】** to save. Set right limit of the motion detection area: operate the joystick to **【SET RIGHT LIMIT】**, press **【OPEN】**, operate joystick to the target position, then press **【OPEN】** to save. When the left & right limit is set at the same point, the speed dome will track the moving object with pan 360° area.

5. Set upper limit of the motion detection area: operate the joystick to **【SET UP LIMIT】**, press **【OPEN】**, operate joystick to the target position, then press **【OPEN】** to save. Set down limit of the motion detection area: operate the joystick to **【SET DOWN LIMIT】**, press **【OPEN】**, operate joystick to the target position, then press **【OPEN】** to save. When the up & down limit is set at the same point, the speed dome will track the moving object within tilt 360° area.

6. **【PARK TIME】** The setting allows PTZ to execute the next designated action after it is in idle state (for 1-240 seconds) on condition that it is under the “Auto Tracking” Mode. The default setting is 000, which means no action.

- a) Under the “Auto Tracking” Mode.
- b) TRACKING PARA → PARK TIME, which setting is not “0”
- c) TRACKING PARA → PARK TIME, which setting is not “none”

When reaching the above 3 conditions at the same time:

It will execute the function under **【TRACKING PARA → PARK TIME 000S PARK ACTION NONE】**, but it won't execute the function under **【MOTION → PARK TIME 000 PARK ACTION NONE】**. When can't reach the above 3 conditions at the same time: It will execute the function under **【MOTION → PARK TIME 000 PARK ACTION NONE】**, but but it won't execute the function under **【TRACKING PARA → PARK TIME 000S PARK ACTION NONE】**

Call 250 preset to set the Auto Tracking function ON. Call 251 preset to set the Auto Tracking function OFF. The speed dome will not resume keeping the Auto Tracking function when it power on.



**NOTICE**

The speed dome will track the moving object at random when there are too many objects in tracking area. Too light or too dark will influence the effect of auto tracking.

The function relates to the speed dome and build-in camera modules; the item will not be showed or “N/A” when the camera doesn't have such function.

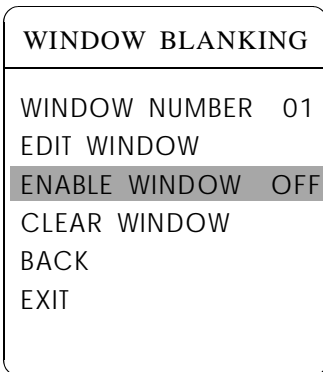
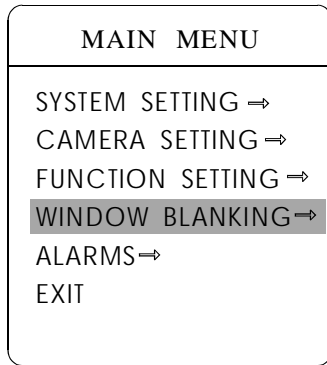

## 7. Privacy zone masking

Privacy function can show someone piece of regional shielding while protecting. For example, protect the window of bedroom or ATM of bank. A PTZ can set up to 24 privacy windows. (Masking setting function is relative with the model of camera module. The masking numbers will be different according to the different cameras.)

**Hitachi Camera:** It can be set 8 masking at most in 360° surveillance range, can set 2 masking at most per screen. The screen will note " please move " when the position can not be set. It can not set masking when the PTZ rotates down  $\geq 45^\circ$  .

**Sony Camera:** It can be set 24 masking at most in 360° surveillance range. ( Sony 45 series can be set 8 masking at most ). It can not set masking when the PTZ rotates down  $\geq 20^\circ$  . LG, CNB Camera module have no masking function.

- 1、 The system enters into the main menu by calling 95 preset or by calling 9 preset twice within 3 seconds.
- 2、 Operate the joystick to **【WINDOW BLANKING】** , press **【OPEN】** to enter menu “ window blanking” .
  - **【WINDOW NUMBER】** choose window number as current privacy window, other choices in the menu just aim at current privacy window;
  - **【EDIT WINDOW】** program current window;
  - **【ENABLE WINDOW】** permit/prohibit current privacy window, there are two choices: ON---permit current privacy window/OFF---prohibit current privacy window
  - **【CLEAR WINDOW】** clear current privacy window, after clearing it, the window will auto- change as OFF.
- 3、 Program current privacy window: Firstly choose window number, then do the following operations:
  - a. Operate the joystick, move the cursor to **【EDIT WINDOW】** , press **【OPEN】** to move the image that need privacy window to display in the screen.
  - b. Press **【OPEN】** , there will be a square displaying in the center of the screen, operate the joystick, and move the square to the central place that need to conceal.
  - c. Press **【OPEN】** , operate the joystick to adjust the size of privacy zone: joystick to up, the height is increased; joystick to down, the height is reduced; joystick to right, the width is increased; joystick to left, the width is reduced.
  - d. Press **【OPEN】** to save the current privacy zone setting, and the window will auto-change as ON at the same time.

Privacy zone masking



This function is decide by the parameter of built-in camera, if the camera has not this function, this option is invalid. (N/A)

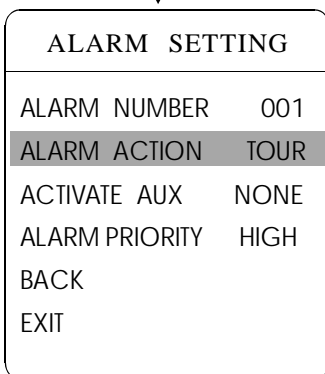
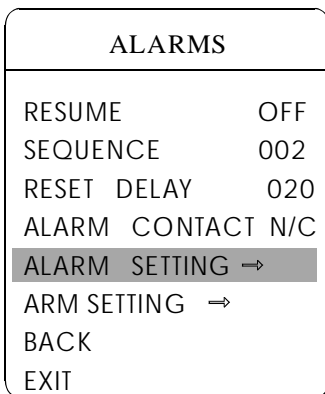
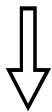
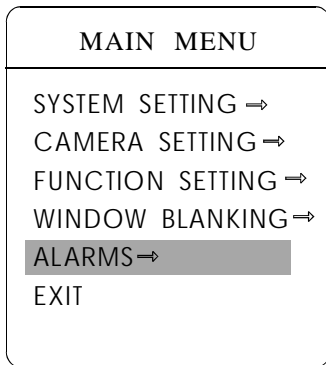

## 8. Alarm function

The PTZ may connect with 7 alarm input, 2 alarm output, and support alarm linkage. The external alarm message sends to the PTZ, then the PTZ sends to alarm point shoot (to call preset, auto scan, auto cruise and auto pattern), and choose that to run alarm output or not.

1、 The system enters into the main menu by calling 95 preset or by calling 9 preset twice within 3 seconds. click each menu according to the left picture, then enter menu alarm, choices as follow:

- **【RESUME】** resume mode after relieving alarm input, there are two choices: ON---clear alarm output, the PTZ will stop.  
OFF---just clear alarm output.
- **【SEQUENCE】** The park time between two alarm in the same priority, the range is 1-60s.
- **【RESET DELAY】** set alarm reset and delay the time (1-225s), how long to relieve and run **【RESUME】** after the PTZ receives alarm message.
- **【ALARM CONTACT】** set state of the relay. N/C---often close the state, N/O---often hold the state. If setting as often closing the state, the relay is in closing the state when there is no alarm to output; when there is alarm to output, the relay is in holding the state.
- **【ALARM SETTING】**
- **【ARM SETTING】**

2、 Operate joystick, move the cursor to **【ALARM SETTING】** , press **【OPEN】** to enter the menu alarm setting

- **【ALARM NUMBER】** alarm number is corresponding with 12 bits plug in the external switching board of the PTZ (as below shows). 001 priority is the highest, 007 priority is the lowest. The two lines alarm input at the same time, the PTZ run alarm that the highest priority.
- **【ALARM ACTION】** as current alarm input, to run the action. Choices for choosing as follow.  
NONE---none action/SCAN/PAT X---run a pattern tour  
TOUR---run tour/PRESET---call preset, when the PTZ number is set as 1, to call preset 1; when the PTZ number is set as 2, to call preset2.
- **【ACTIVATE AUX】** as current alarm input, to run alarm output or not.  
NONE---none alarm output/AUX 1---the first alarm output/  
AUX 2---the secretaryond alarm output/BOTH--- two alarms output.
- **【ALARM PRIORITY】** alarm priority can be defined as three grades: high, middle, low.

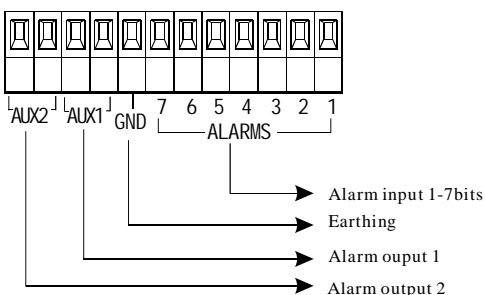

# Alarm Function

MAIN MENU	
SYSTEM SETTING →	
CAMERA SETTING →	
FUNCTION SETTING →	
WINDOW BLANKING →	
<b>ALARMS →</b>	
EXIT	



ALARMS	
RESUME	OFF
SEQUENCE	002
RESET DELAY	020
ALARM CONTACT	N/C
ALARM SETTING →	
<b>ARM SETTING →</b>	
BACK	
EXIT	

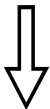

ARM SETTING	
DAY	SUN
<b>ARM STATE</b>	<b>OFF</b>
ARM TIME	N/A
UNARM TIME	N/A
BACK	
EXIT	

## 8.1 ARM Setting

1. Call 95 preset or call 9 preset twice within 3 seconds and then input the password to enter the main menu.
2. Operate the joystick up and down, move the cursor to **【ALARMS】**, press **【OPEN】** to call the submenu.
3. Operate the joystick up and down, move the cursor to **【ARM SETTING】**, press **【OPEN】** to call the submenu. Please refer to the left picture.
4. Operate the joystick up and down, move the cursor to **【DAY】**, Press **【OPEN】** to choose it, Operate the joystick up and down to set date, set the date according to the week. To set the Alarm state and Alarm date based on the time.

- **【ARM STATE】** Alarm off / Alarm on  
(Alarm Setting is noneffective under Alarm off. Alarm Setting is effective under Alarm on)
- **【ARM TIME】** : User can set the alarm time.
- **【UNARM TIME】** : User can set the alarm off time.
- **【BACK】** : back to the former menu.
- **【EXIT】** : Exit the menu.

# 9 Appendix

## 9.1 Menu Index

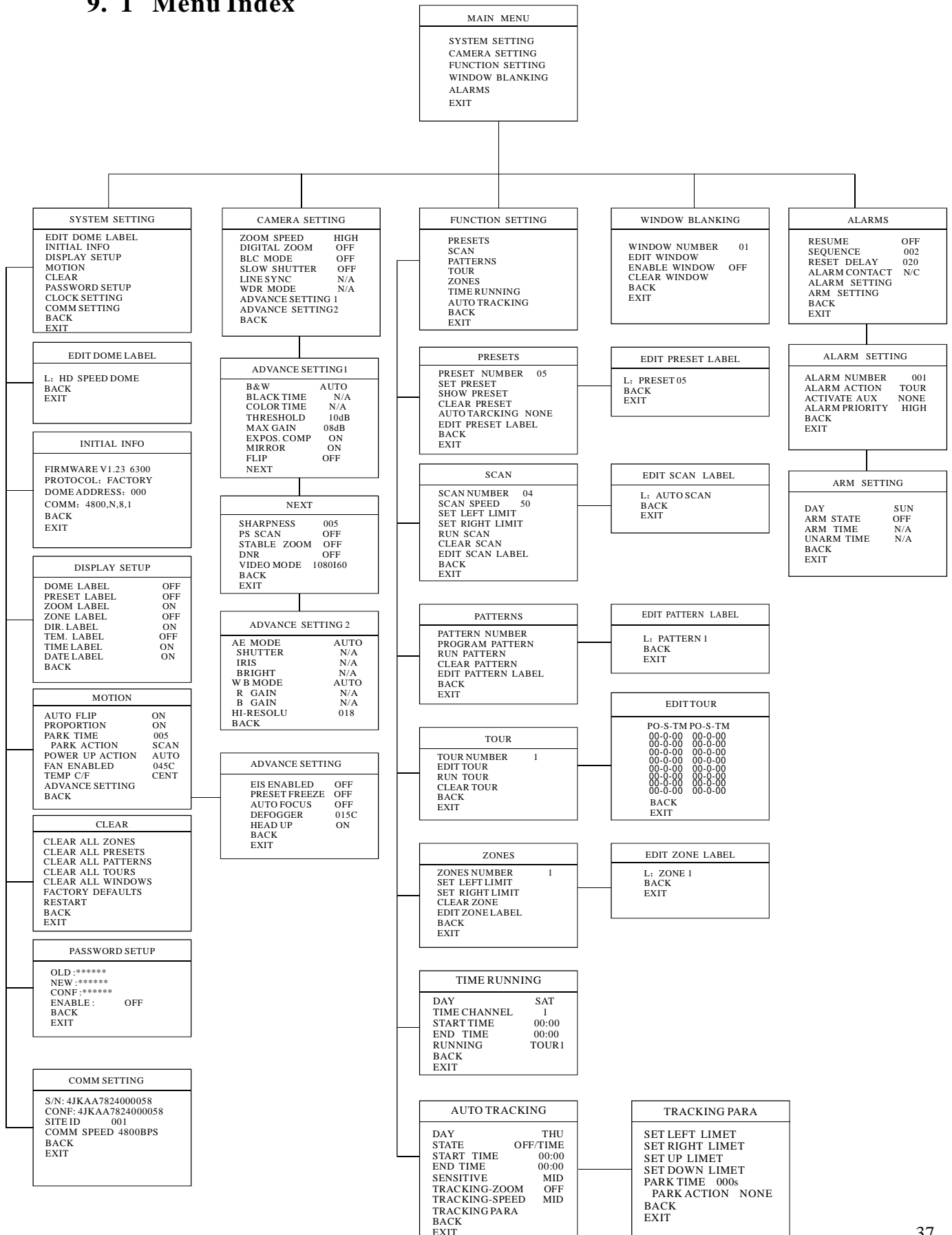



## 9.2 24VAC Wire Diameter and Transmission Distance Comparison chart

The transmission distances listed below are farthest ones recommended for each giving wire diameter when the 24VAC voltage loss ratio is below 10% (for equipment powered by AC, the allowed maximum voltage loss ratio is 10%).

The rating power of PTZ is 50W, need a wire with a minimum diameter of 1.0mm.

Wire Diameter (mm)	0.800	1.000	1.250	2.000
Transmission Distance feet(m)				
Power(va)				
10	283 (86)	451 (137)	716 (218)	1811 (551)
20	141 (42)	225 (68)	358 (109)	905 (275)
30	94 (28)	150 (45)	238 (72)	603 (183)
40	70 (21)	112 (34)	197 (54)	452 (137)
50	56 (17)	90 (27)	143 (43)	362 (110)
60	47 (14)	75 (22)	119 (36)	301 (91)
70	40 (12)	64 (19)	102 (31)	258 (78)
80	35 (10)	56 (17)	89 (27)	226 (68)
90	31 (9)	50 (15)	79 (24)	201 (61)
100	28 (8)	45 (13)	71 (21)	181 (55)
110	25 (7)	41 (12)	65 (19)	164 (49)
120	23 (7)	37 (11)	59 (17)	150 (45)
130	21 (6)	34 (10)	55 (16)	139 (42)
140	20 (6)	32 (9)	51 (15)	129 (39)
150	18 (5)	30 (9)	47 (14)	120 (36)
160	17 (5)	28 (8)	44 (13)	113 (34)
170	16 (4)	26 (7)	42 (12)	106 (32)
180	15 (4)	25 (7)	39 (11)	100 (30)
190	14 (4)	23 (7)	37 (11)	95 (28)
200	14 (4)	22 (6)	35 (10)	90 (27)

### 9.3 Domestic and Abroad Wire Gauge Conversion Chart

Bare Wire Diameter Metric Size(mm)	AWC (Approximate)	SWC (Approximate)	Bare Wire Cross-Sectional Area (mm <sup>2</sup> )
0.050	43	47	0.00196
0.060	42	46	0.00283
0.070	41	45	0.00385
0.080	40	44	0.00503
0.090	39	43	0.00636
0.100	38	42	0.00785
0.110	37	41	0.00950
0.130	36	39	0.01327
0.140	35		0.01539
0.160	34	37	0.02011
0.180	33		0.02545
0.200	32	35	0.03142
0.230	31		0.04115
0.250	30	33	0.04909
0.290	29	31	0.06605
0.330	28	30	0.08553
0.350	27	29	0.09621
0.400	26	28	0.1257
0.450	25		0.1602
0.560	24	24	0.2463
0.600	23	23	0.2827
0.710	22	22	0.3958
0.750	21		0.4417
0.800	20	21	0.5027
0.900	19	20	0.6362
1.000	18	19	0.7854
1.250	16	18	1.2266
1.500	15		1.7663
2.000	12	12	3.1420
2.500			4.9080
3.000			7.0683

## 9. 4 Rs485 Bus Basic Knowledge

### Ø Characteristics of Rs485 Bus

As specified by Rs485 standard, Rs485 Bus is of half-duplexed data transmission cables with characteristic impedance as 120Ω. The maximum load capacity is 32 unit loads (including main controller and controlled equipment.)

### Ø Transmission distances of Rs485 Bus

When user selects the 0.56mm(24AWG)twisted pair wires as data transmission cable, the maximum theoretical transmitting distance are as follows:

Baud rate	Max distance
2400BPS	1800m
4800BPS	1200m
9600BPS	800m
19200BPS	600m

If user selects thinner cables, or installs the PTZ in an environment with strong electromagnetic interference, or connects lots of equipment to the Rs485 Bus, the maximum transmitting distance will be decreased. To increase the maximum transmitting distance, do the contrary.

### Ø Connection and termination resistor

The Rs485 standards require a daisy-chain Connection between the equipment. There must be termination resistors with 120Ω (as the picture 9-2.1). Please refer to picture 9-2.2 for simple connection.

“D” should not exceed 7m.

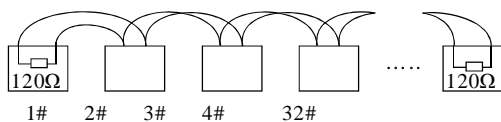

Picture 9-4.1

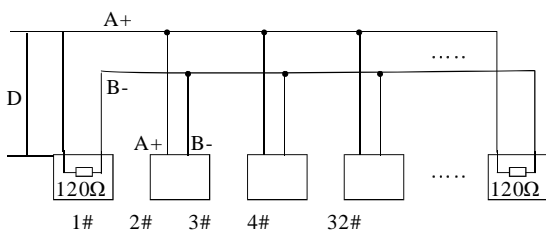

Picture 9-4.2

### Ø The connection of 120Ω termination resistor:

The termination resistor is ready on the protocol PCB. There are two kinds of connection (as shown in 9-4.3 form). It is the factory default connection. The jumper cap of the switchboard is seated on pin 2 & pin 3 and the termination resistor 120Ω is not connected.

When connecting the 120Ω termination resistor, user should pull out the protocol PCB and plug the jumper on pin 1 & pin 2. Install the PCB back and the termination resistor is connected. (as shown in the picture 9-4.3)

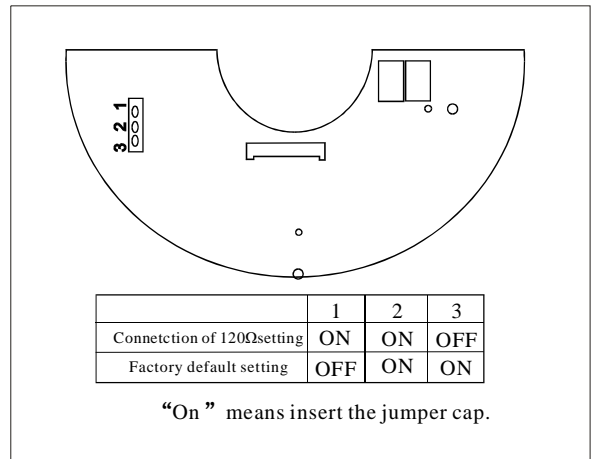

Picture9-4.3

**Ø Problems in practical connections**

In some circumstances user adopts a star configuration in practical connection. The termination resistors must be connected to the two equipment 1# and 5# in Picture 9-4.4. As the star configuration is not in conformity with the requirements of RS485 standards, problems such as signal reflections, lower anti-interference performance arise when the cables are long in the connection. The reliability of control signals is decreased with the phenomena that the PTZ does not respond to or just responds at intervals to the controller, or does continuous operation without stop.

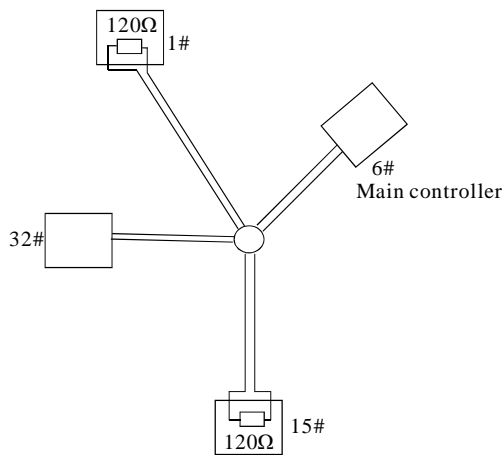

Picture 9-4.4

In such circumstances the factory recommends the usage of RS485 distributor. The distributor can change the star configuration connection to the mode of connection stipulated in the RS485 standards. The new connection achieves reliable data transmission. (Refer to Picture 9-4.5).

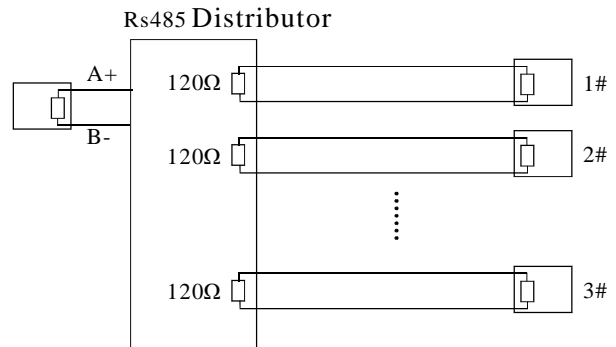

Picture9-4.5

**Ø Rs485 Bus troubleshooting**

Trouble	Possible cause	Solution
PTZ can do self-testing but cannot be controlled	A、 The address and baud rate setting of PTZ are not in conformity with those of controller. B、 The "+" and "-"connection of Rs485 Bus is incorrect. C、 The PTZ is very far away from controller. D、 There are too many PTZs connected in the System.	A、 Change the address and baud rate of controller or PTZ B、 Replace Rs485 Bus wires C、 Make sure the connections are fully seated
The PTZ can be controlled but the operation is not smooth.	A、 The Rs485 Bus line is not in good contact with the connectors. B、 One wire of the Rs485 Bus is broken. C、 The PTZ is very far from controller. D、 There are too many PTZ connected in the system.	A、 Secure the connection; B、 Replace Rs485 Bus Wires C、 Add termination resistors to the system D、 Install Rs485 distributor

## 9. 5 DIP switch setup

Open the right side cover, there are two 8digits code switch, SW1 and SW2. SW1 is for setting of PTZ ID; SW2 is for settings of control protocol, baud rate, terminal resistance connect.

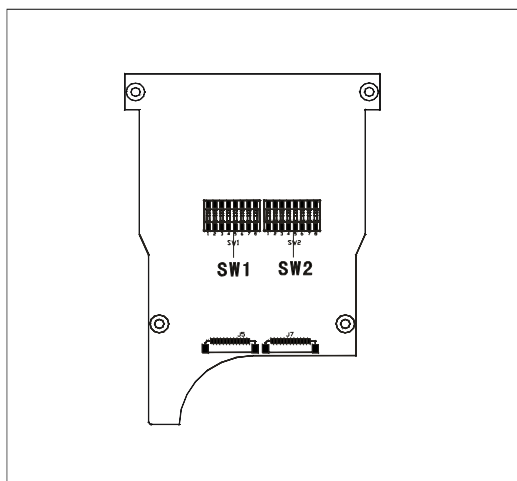

In the following list, “1” set DIP as “ON” 0 set DIP as “OFF”

Picture 9-5.1

### 9. 5. 1 Baud rate setup (SW2) :

Please according to "AppdienxRS485 Bus Basic knowledge", to check whether Baud rate is satisfied with the demand of transmission distance.

Baud rate	Switch number(Sw2)
	(Bit)7 8
2400bps	0 0
4800bps	1 0
9600bps	0 1
19200bps	1 1

### 9. 5. 2 Protocol setup (SW2)

PROTOCOL	SWITCH NUMBER ( SW2 )					
	(Bit) 1	2	3	4	5	6
FACTORY (FACTORY PROTOCOL)	0	0	0	0	0	0
PELCO	1	0	0	0	0	0
SAE	0	1	0	0	0	0
VAC	1	1	0	0	0	0
MOLYNX	0	0	1	0	0	0
VICON	1	0	1	0	0	0
SANTACHI	0	1	1	0	0	0
PANASONIC	1	1	1	0	0	0
SAMSUNG	0	0	0	1	0	0
DIAMOND	1	0	0	1	0	0
KALATEL	0	1	0	1	0	0
LILIN	1	1	0	1	0	0
VIDO B02	0	0	1	1	0	0
HUNDA	1	0	1	1	0	0
ISO	0	1	1	1	0	0
DYNACOLOR	1	1	1	1	0	0
ST-SD	1	0	0	0	1	0
PHILIPS	0	0	0	0	0	1
AD	1	0	0	0	0	1
RESERVED	OTHERS					

### 9. 5. 3 ID setting (SW1)

The ID switch in decoder and the ID setting of the PTZ as follow, in the picture, "1" set DIP switch as "NO", "0" set DIP switch as OFF.

ID	Switch number (SW1)								ID	Switch number (SW1)							
	(Bit)	1	2	3	4	5	6	7		8	(Bit)	1	2	3	4	5	6
Factory defaults set as debug address	0	0	0	0	0	0	0	0	34	0	1	0	0	0	1	0	0
1	1	0	0	0	0	0	0	0	35	1	1	0	0	0	1	0	0
2	0	1	0	0	0	0	0	0	36	0	0	1	0	0	1	0	0
3	1	1	0	0	0	0	0	0	37	1	0	1	0	0	1	0	0
4	0	0	1	0	0	0	0	0	38	0	1	1	0	0	1	0	0
5	1	0	1	0	0	0	0	0	39	1	1	1	0	0	1	0	0
6	0	1	1	0	0	0	0	0	40	0	0	0	1	0	1	0	0
7	1	1	1	0	0	0	0	0	41	1	0	0	1	0	1	0	0
8	0	0	0	1	0	0	0	0	42	0	1	0	1	0	1	0	0
9	1	0	0	1	0	0	0	0	43	1	1	0	1	0	1	0	0
10	0	1	0	1	0	0	0	0	44	0	0	1	1	0	1	0	0
11	1	1	0	1	0	0	0	0	45	1	0	1	1	0	1	0	0
12	0	0	1	1	0	0	0	0	46	0	1	1	1	0	1	0	0
13	1	0	1	1	0	0	0	0	47	1	1	1	1	0	1	0	0
14	0	1	1	1	0	0	0	0	48	0	0	0	0	1	1	0	0
15	1	1	1	1	0	0	0	0	49	1	0	0	0	1	1	0	0
16	0	0	0	0	1	0	0	0	50	0	1	0	0	1	1	0	0
17	1	0	0	0	1	0	0	0	51	1	1	0	0	1	1	0	0
18	0	1	0	0	1	0	0	0	52	0	0	1	0	1	1	0	0
19	1	1	0	0	1	0	0	0	53	1	0	1	0	1	1	0	0
20	0	0	1	0	1	0	0	0	54	0	1	1	0	1	1	0	0
21	1	0	1	0	1	0	0	0	55	1	1	1	0	1	1	0	0
22	0	1	1	0	1	0	0	0	56	0	0	0	1	1	1	0	0
23	1	1	1	0	1	0	0	0	57	1	0	0	1	1	1	0	0
24	0	0	0	1	1	0	0	0	58	0	1	0	1	1	1	0	0
25	1	0	0	1	1	0	0	0	59	1	1	0	1	1	1	0	0
26	0	1	0	1	1	0	0	0	60	0	0	1	1	1	1	0	0
27	1	1	0	1	1	0	0	0	61	1	0	1	1	1	1	0	0
28	0	0	1	1	1	0	0	0	62	0	1	1	1	1	1	0	0
29	1	0	1	1	1	0	0	0	63	1	1	1	1	1	1	0	0
30	0	1	1	1	1	0	0	0	64	0	0	0	0	0	0	1	0
31	1	1	1	1	1	0	0	0	65	1	0	0	0	0	0	1	0
32	0	0	0	0	0	1	0	0	66	0	1	0	0	0	0	1	0
33	1	0	0	0	0	1	0	0	67	1	1	0	0	0	0	1	0

# Appendix

ID	Switch number (Sw1)							
	(Bit)1	2	3	4	5	6	7	8
68	0	0	1	0	0	0	1	0
69	1	0	1	0	0	0	1	0
70	0	1	1	0	0	0	1	0
71	1	1	1	0	0	0	1	0
72	0	0	0	1	0	0	1	0
73	1	0	0	1	0	0	1	0
74	0	1	0	1	0	0	1	0
75	1	1	0	1	0	0	1	0
76	0	0	1	1	0	0	1	0
77	1	0	1	1	0	0	1	0
78	0	1	1	1	0	0	1	0
79	1	1	1	1	0	0	1	0
80	0	0	0	0	1	0	1	0
81	1	0	0	0	1	0	1	0
82	0	1	0	0	1	0	1	0
83	1	1	0	0	1	0	1	0
84	0	0	1	0	1	0	1	0
85	1	0	1	0	1	0	1	0
86	0	1	1	0	1	0	1	0
87	1	1	1	0	1	0	1	0
88	0	0	0	1	1	0	1	0
89	1	0	0	1	1	0	1	0
90	0	1	0	1	1	0	1	0
91	1	1	0	1	1	0	1	0
92	0	0	1	1	1	0	1	0
93	1	0	1	1	1	0	1	0
94	0	1	1	1	1	0	1	0
95	1	1	1	1	1	0	1	0
96	0	0	0	0	0	1	1	0
97	1	0	0	0	0	1	1	0
98	0	1	0	0	0	1	1	0
99	1	1	0	0	0	1	1	0
100	0	0	1	0	0	1	1	0
101	1	0	1	0	0	1	1	0

ID	Switch number (Sw1)							
	(Bit)1	2	3	4	5	6	7	8
102	0	1	1	0	0	1	1	0
103	1	1	1	0	0	1	1	0
104	0	0	0	1	0	1	1	0
105	1	0	0	1	0	1	1	0
106	0	1	0	1	0	1	1	0
107	1	1	0	1	0	1	1	0
108	0	0	1	1	0	1	1	0
109	1	0	1	1	0	1	1	0
110	0	1	1	1	0	1	1	0
111	1	1	1	1	0	1	1	0
112	0	0	0	0	1	1	1	0
113	1	0	0	0	1	1	1	0
114	0	1	0	0	1	1	1	0
115	1	1	0	0	1	1	1	0
116	0	0	1	0	1	1	1	0
117	1	0	1	0	1	1	1	0
118	0	1	1	0	1	1	1	0
119	1	1	1	0	1	1	1	0
120	0	0	0	1	1	1	1	0
121	1	0	0	1	1	1	1	0
122	0	1	0	1	1	1	1	0
123	1	1	0	1	1	1	1	0
124	0	0	1	1	1	1	1	0
125	1	0	1	1	1	1	1	0
126	0	1	1	1	1	1	1	0
127	1	1	1	1	1	1	1	0
128	0	0	0	0	0	0	0	1
129	1	0	0	0	0	0	0	1
130	0	1	0	0	0	0	0	1
131	1	1	0	0	0	0	0	1
132	0	0	1	0	0	0	0	1
133	1	0	1	0	0	0	0	1
134	0	1	1	0	0	0	0	1
135	1	1	1	0	0	0	0	1

ID	Switch number (SW1)								ID	Switch number (SW1)							
	(Bit)	1	2	3	4	5	6	7		8	(Bit)	1	2	3	4	5	6
136	0	0	0	1	0	0	0	1	170	0	1	0	1	0	1	0	1
137	1	0	0	1	0	0	0	1	171	1	1	0	1	0	1	0	1
138	0	1	0	1	0	0	0	1	172	0	0	1	1	0	1	0	1
139	1	1	0	1	0	0	0	1	173	1	0	1	1	0	1	0	1
140	0	0	1	1	0	0	0	1	174	0	1	1	1	0	1	0	1
141	1	0	1	1	0	0	0	1	175	1	1	1	1	0	1	0	1
142	0	1	1	1	0	0	0	1	176	0	0	0	0	1	1	0	1
143	1	1	1	1	0	0	0	1	177	1	0	0	0	1	1	0	1
144	0	0	0	0	1	0	0	1	178	0	1	0	0	1	1	0	1
145	1	0	0	0	1	0	0	1	179	1	1	0	0	1	1	0	1
146	0	1	0	0	1	0	0	1	180	0	0	1	0	1	1	0	1
147	1	1	0	0	1	0	0	1	181	1	0	1	0	1	1	0	1
148	0	0	1	0	1	0	0	1	182	0	1	1	0	1	1	0	1
149	1	0	1	0	1	0	0	1	183	1	1	1	0	1	1	0	1
150	0	1	1	0	1	0	0	1	184	0	0	0	1	1	1	0	1
151	1	1	1	0	1	0	0	1	185	1	0	0	1	1	1	0	1
152	0	0	0	1	1	0	0	1	186	0	1	0	1	1	1	0	1
153	1	0	0	1	1	0	0	1	187	1	1	0	1	1	1	0	1
154	0	1	0	1	1	0	0	1	188	0	0	1	1	1	1	0	1
155	1	1	0	1	1	0	0	1	189	1	0	1	1	1	1	0	1
156	0	0	1	1	1	0	0	1	190	0	1	1	1	1	1	0	1
157	1	0	1	1	1	0	0	1	191	1	1	1	1	1	1	0	1
158	0	1	1	1	1	0	0	1	192	0	0	0	0	0	0	1	1
159	1	1	1	1	1	0	0	1	193	1	0	0	0	0	0	1	1
160	0	0	0	0	0	1	0	1	194	0	1	0	0	0	0	1	1
161	1	0	0	0	0	1	0	1	195	1	1	0	0	0	0	1	1
162	0	1	0	0	0	1	0	1	196	0	0	1	0	0	0	1	1
163	1	1	0	0	0	1	0	1	197	1	0	1	0	0	0	1	1
164	0	0	1	0	0	1	0	1	198	0	1	1	0	0	0	1	1
165	1	0	1	0	0	1	0	1	199	1	1	1	0	0	0	1	1
166	0	1	1	0	0	1	0	1	200	0	0	0	1	0	0	1	1
167	1	1	1	0	0	1	0	1	201	1	0	0	1	0	0	1	1
168	0	0	0	1	0	1	0	1	202	0	1	0	1	0	0	1	1
169	1	0	0	1	0	1	0	1	203	1	1	0	1	0	0	1	1



ID	Switch number (Sw1)							
	(Bit)1	2	3	4	5	6	7	8
204	0	0	1	1	0	0	1	1
205	1	0	1	1	0	0	1	1
206	0	1	1	1	0	0	1	1
207	1	1	1	1	0	0	1	1
208	0	0	0	0	1	0	1	1
209	1	0	0	0	1	0	1	1
210	0	1	0	0	1	0	1	1
211	1	1	0	0	1	0	1	1
212	0	0	1	0	1	0	1	1
213	1	0	1	0	1	0	1	1
214	0	1	1	0	1	0	1	1
215	1	1	1	0	1	0	1	1
216	0	0	0	1	1	0	1	1
217	1	0	0	1	1	0	1	1
218	0	1	0	1	1	0	1	1
219	1	1	0	1	1	0	1	1
220	0	0	1	1	1	0	1	1
221	1	0	1	1	1	0	1	1
222	0	1	1	1	1	0	1	1
223	1	1	1	1	1	0	1	1
224	0	0	0	0	0	1	1	1
225	1	0	0	0	0	1	1	1
226	0	1	0	0	0	1	1	1
227	1	1	0	0	0	1	1	1
228	0	0	1	0	0	1	1	1
229	1	0	1	0	0	1	1	1
230	0	1	1	0	0	1	1	1
231	1	1	1	0	0	1	1	1
232	0	0	0	1	0	1	1	1
233	1	0	0	1	0	1	1	1
234	0	1	0	1	0	1	1	1
235	1	1	0	1	0	1	1	1
236	0	0	1	1	0	1	1	1
237	1	0	1	1	0	1	1	1
ID	Switch number (Sw1)							
	(Bit)1	2	3	4	5	6	7	8
238	0	1	1	1	0	1	1	1
239	1	1	1	1	0	1	1	1
240	0	0	0	0	1	1	1	1
241	1	0	0	0	1	1	1	1
242	0	1	0	0	1	1	1	1
243	1	1	0	0	1	1	1	1
244	0	0	1	0	1	1	1	1
245	1	0	1	0	1	1	1	1
246	0	1	1	0	1	1	1	1
247	1	1	1	0	1	1	1	1
248	0	0	0	1	1	1	1	1
249	1	0	0	1	1	1	1	1
250	0	1	0	1	1	1	1	1
251	1	1	0	1	1	1	1	1
252	0	0	1	1	1	1	1	1
253	1	0	1	1	1	1	1	1
254	0	1	1	1	1	1	1	1
255	1	1	1	1	1	1	1	1



**Notice:** Debug address: (Only factory protocol and Pelco can be set): if the camera address is set as 0, user can select any protocols to control the PTZ.

## 10. Installation

### 10.1 Caution

- | Please refer to user manual before installation.
- | Power: AC220V/110V-AC24V, for actual needs, please refer to label of product.
- | Precise optical and electronic parts inside of product. Avoiding severe press, hard vibration etc non-correct operation methods, which may cause damage to product when transportation and installation.
- | Please do not disassemble parts inside of product at random, which may cause negative influence on use of product. No additional parts available.
- | Please comply with standards of Electrify Safety and use our own power transformer of product. Enough distance must be ensured between RS-485 cable, Video signal cable and equipments of high voltage when transmission. Thunder-proof, surge-proof and wave-proof , etc protection measures are needed.
- | Do not use product beyond the rated temperature, humidity or specifications of power. Do not place camera point to Sun or shining objects.
- | Do not use cleansers with abrasion to clean product. Please use dry cloth to clean up dirt; Neutral cleanser is needed when not easy to clean.
- | Handle product with care so as to avoid crash or vibration; Damage is caused when incorrect usage.
- | Please fix product to the position which is solid and firm.
- | Please use special paper of lens to clean up dirt on Lens.

### 10.2 Distributing the Line in Security

Please refer to right picture 11.1-1

= It is necessary to keep 50 meters distances at least between the high voltage unit and the high voltage cable with signal transmission line.

= Outdoor wiring is best to along under the eave of the house.

= Wiring at void place must adopt by way of sealed steel tube bury underground, and sealed steel tube should be grounded by one Bus. It is absolutely forbidden to adopt wiring without holder.

= Under thunderstorm or high inductive voltage region (e.g.: high voltage transformer substation), you must add extra high power lightning proof equipment and install lightning rob.

= Outdoor equipment, routes of lighting proof and ground design must consider according to the request of construction lightning proof, and coincide with connection requests of country and industry standard.

- The system must equipotential ground. Grounding equipment must satisfy the anti-jamming and electrical safety requirements and must not short circuited or mix connection with high voltage electricity net. When the system is grounded separately, the ground resistance should be not more than  $4\Omega$  and section of the grounding conducting wire should be less than  $25\text{ mm}^2$ .

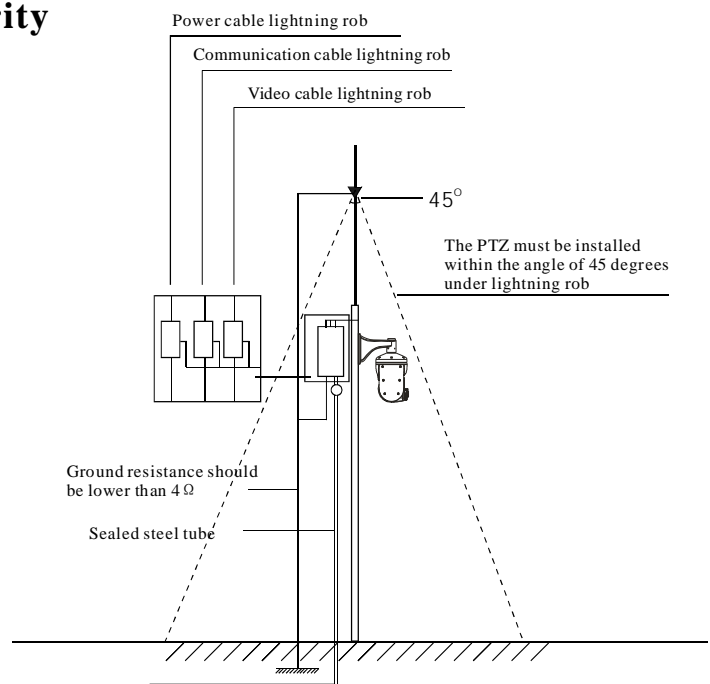

Picture11-1.1

## 10.3 Lightning Proof and Surge Proof

This product uses TVS lightning Proof technology, can prevent from the damage of the equipment caused by kinds of pulse signal such as instant lightning strike of power below 4000V, the surge and so on.

At the same time, you must adopt the essential protective measure according to the actual situation regarding outdoor installation under the guarantee electricity security. (Refer to chapter 1.3 Distributing the line in security)

## 10.4 Water Proof

Outdoor PTZ has well waterproof、moisture-proof、dustproof performance, has achieved the IP66 international standard. The indoor PTZ doesn't allowed to install in outdoor environment which is full of moisture and possibly enter water. You should prevent the product and the internal components from damage that caused by the long time water-drop or spatter.

## 10.5 The preparation of installation

### ⊘ The request of the quality of installation person and maintainer:

- All installation and maintenance work related this product should complete by technical personnel who have qualification of installation and maintenance.

### ⊘ Basic requirements

- Please refer to this handbook for detail.
- All electrical work must be observe local latest electricity laws, regulation on fireproof as well as the related laws and regulations:
- Checking everything is completed according to packing list. Make sure the application place and the way of installation for PTZ is coincide with the request. If not, please contact your supplier.
- Please use this product according to the working conditions request.
- Please handle with the pan/tilt module carefully, do not extrude various structure parts; The down cover belongs to the senior optics part, do not touch with hand; Please do not get through power except for the electrifying inspection in process of installation.

### ⊘ Check the structure intensity for installation space and installation site.

- Make sure you have enough space to hold this product and it's parts of installation in the site.
- Make sure the bearing capacity of ceiling, wall, bracket that installs the PTZ support the gross weight of the PTZ and the structural parts of installation. It is necessary to have the safe coefficient of 4 times or above.

## ⊘ Stuff Preparation

Please select the type of cables based on transmitting distance:

- Minimum video coaxial cable requirements:

- 1)75 Ω impedance
- 2)All copper conductor wire
- 3)95% copper net structure

Domestic Gauge	International Gauge	Maximum Distance(ft/m)
RG59/U	RG59/U	750ft (229m)
5C-2V	RG6/U	1,000ft (305m)
7C-2V	RG11/U	1,500ft (457m)

- RS485 Communication cables (Refer to manual appendix)
- 24VAC Power supply cable (Refer to manual appendix)

## ⊘ Keep All the Original Package Materials

Please preserve the mode original package material properly after opening the PTZ packing, in order to mail the PTZ that is wrapped with original package material to the agent or return it to the factory to repair if problem occur.

It is likely to bring on the damage that caused by the transport accident on the way if the mode uses the non-original package material, and extra cost may arise accordingly.

## ⊘ Brief introduction of mounting way

**Mounting way of pan/tilt: wall mount, pendant mount.**



**NOTICE**

**Bracket Installation** Installation position must enable to undertake high weight pressure, which must be 4times of the total weight of PTZ and bracket.

The wall must be strong and stable, bracket must be ensure to install on the real wall but not the surface coating of the wall.

### 10.6 Structure Introduction

The total PTZ consist of Connection plate,Main lid,Side cover,Main body,camera front cover, Wiper, original integrated packing )

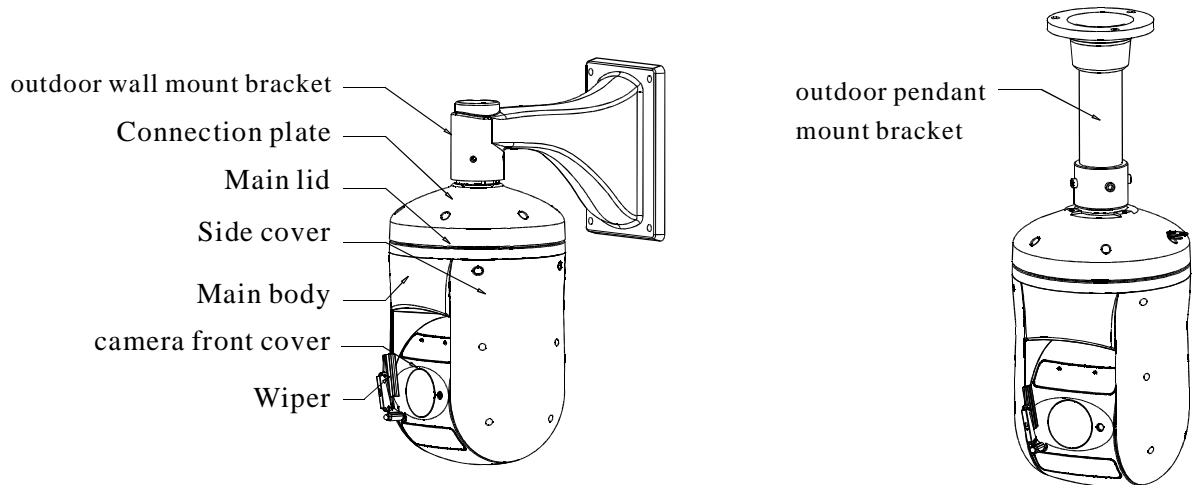

Picture10.6-1

### 10.7 Basic Size graph

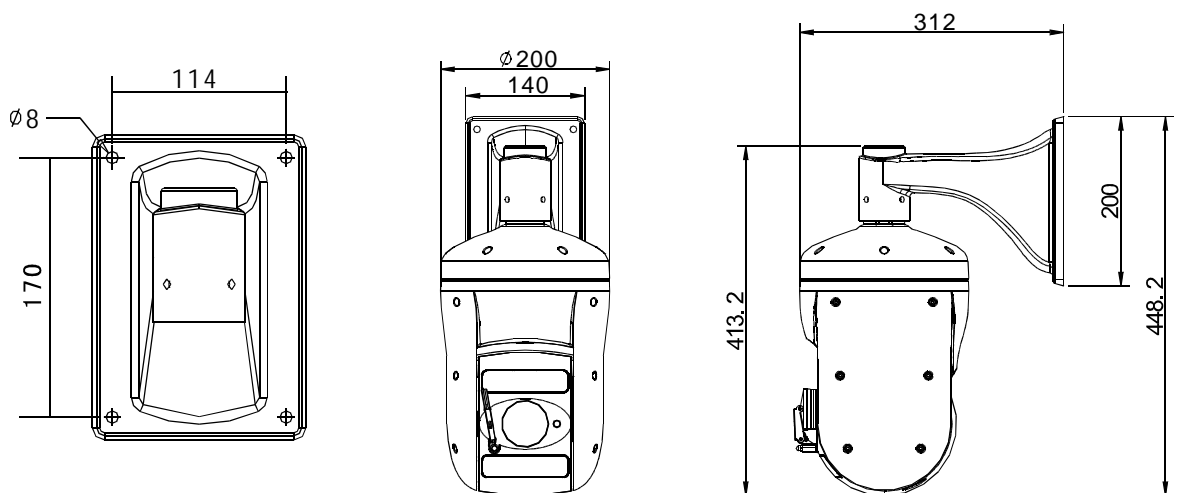

Picture10.7-1

## 10.8. Installation

### 10.8.1 Wall mount



**NOTICE**

1. The installation site must be able to support the sum of weight such as the dome, the bracket and the pedestal four times.
2. The chosen wall of installation site must be solid and have no delaminated phenomenon, must make sure the bracket installs on the wall but not in the superficial slipcover.

On the installation wall, use wall bracket as a templet to mark the center position of the hole (as picture 10-8.1-1 shows).

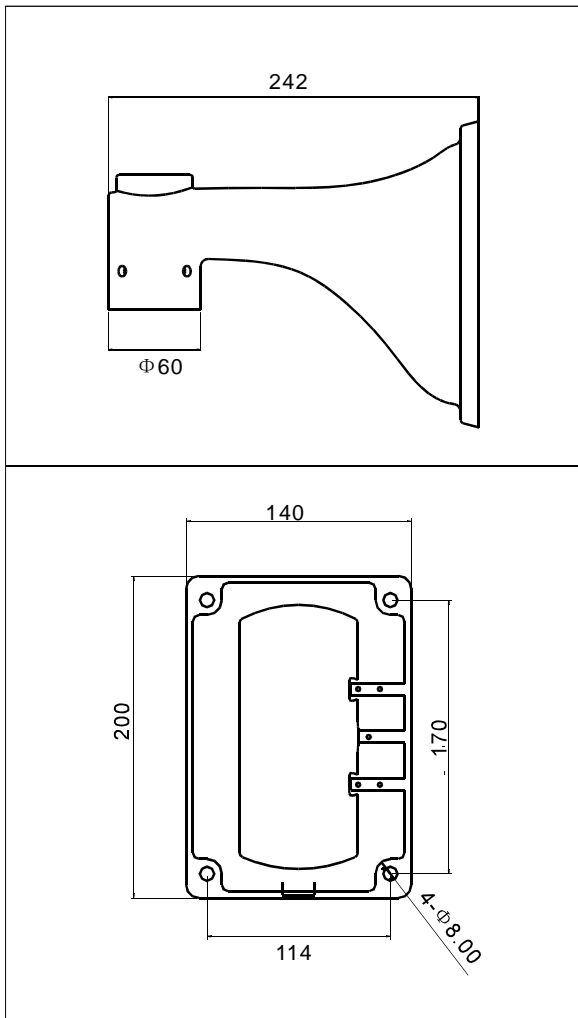

Picture 10-8.1-1

User use the electric drill to drill four M6 holes on the installation surface. The length is around 75mm and then install M6 screw.

Using the 4pcs M6\*12 screws to lock the PTZ and the wall bracket together, then fix them on the wall. As shown in figure 10-8.1-2

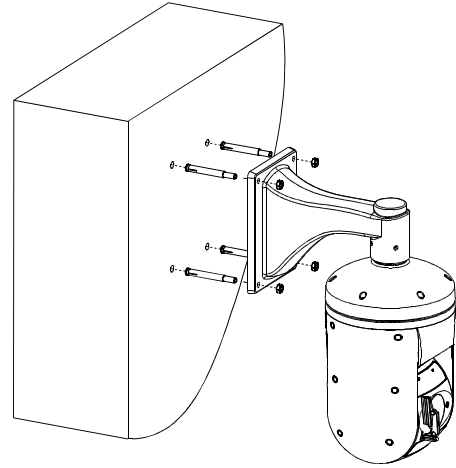

Picture 10-8.1-2

Please see NO.① in the picture, smear the sealed glue on the brim of the bracket and the dome will be prevented the water entering. (as picture 10-8.1-3):

(1) All sides interface between wall mount bracket and the wall.

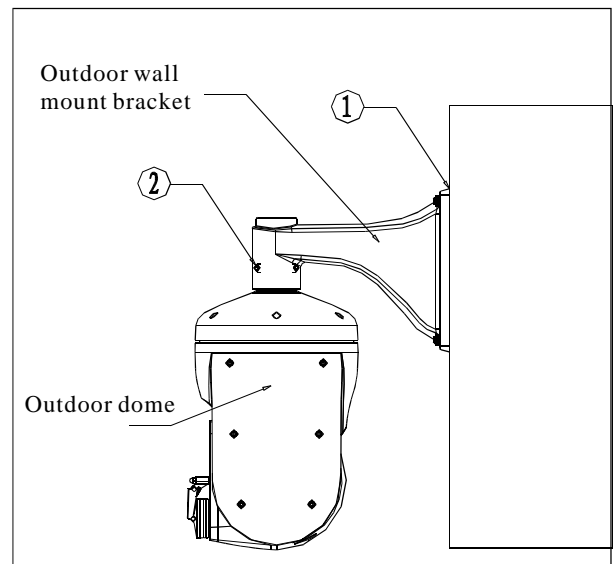

Picture 10-8.1-3



**NOTICE**

The user must install the outdoor bracket according to below requirement strictly. It does not belong to our maintenance scope if the dome was damaged causing by disobey the requirement to install.

## 10.8.2 Pendant mount



1. The installation site must be able to support the sum of weight such as the dome, the bracket and the pedestal four times.
2. The chosen wall of installation site must be solid and have no delaminated phenomenon, must make sure the bracket installs on the wall but not in the superficial slipcover.

On the installation wall, use pendant bracket as a templet to mark the center position of the hole (as picture 10-8.2-1 shows).

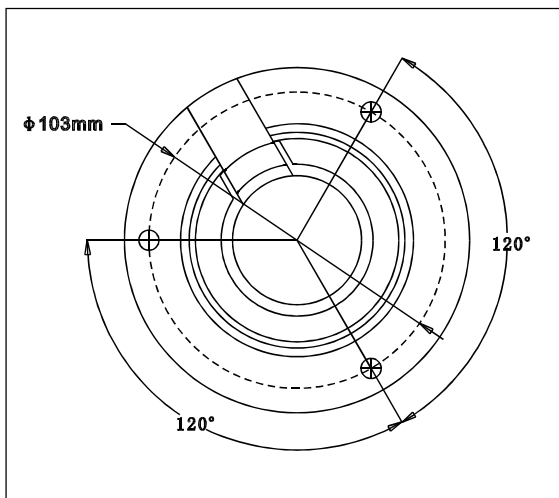

Picture 10-8.2-1

User use the electric drill to drill three M6 holes on the installation surface. The length is around 75mm and then install M6 screw. (as picture 10-8.2-2 shows)

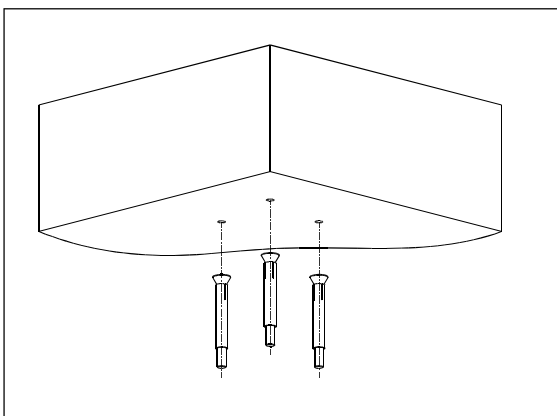

Picture 10-8.2-2

Wind close one side of the connector (G1-1/2") into the base, then use M4\*10 fasten screw to lock the connector.

Using the 4pcs M6\*12 screws to lock the PTZ and the pendant bracket together, then fix them on the wall. As shown in figure 10-8.2-3

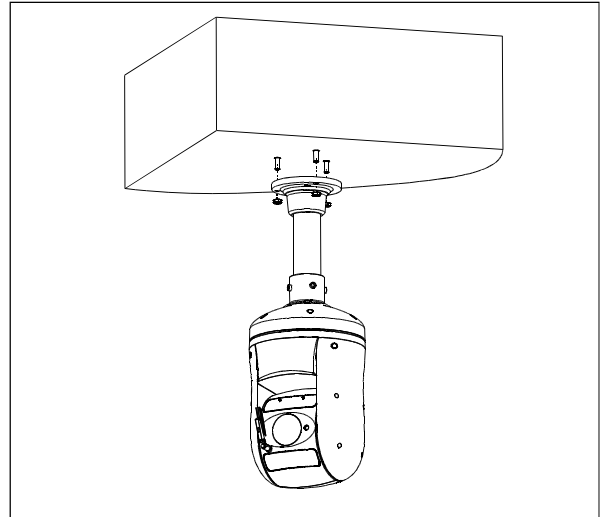

Picture10-8. 2-3



The user must install the outdoor bracket according to below requirement strictly. It does not belong to our maintenance scope if the dome was damaged causing by disobey the requirement to install.

## 10.9 Cabling Connection

According to different night-vision function, you can refer to the following connection drawing:

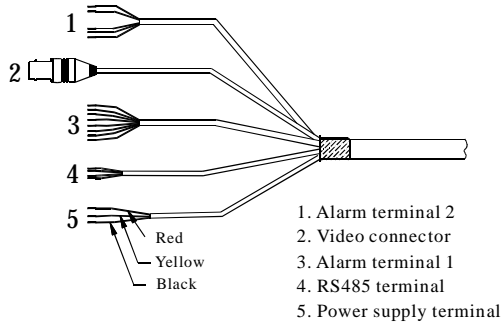

**Connection drawing of Infrared LED**

Picture10.9-1

Please connect cables refer to the attached tag. Detail connection refer to below list.

**Alarm terminal 1 :**

RED:ALM1  
 PINK:ALM2  
 YELLOW:ALM3  
 GREEN:ALM4  
 BLACK:COM  
 WHITE:NO  
 BLUE:NC

**Alarm terminal 2 :**

AQUA:NC2  
 BROWN:NO2  
 GRAY:ALM7  
 PURPLE:ALM6  
 ORANGE:ALM5

**RS485 terminal:**

YELLOW:RS485-  
 GREEN:RS485+

**Power supply terminal:**

RED:AC24V+  
 YELLOW: GROUNDING  
 BLACK:AC24V-

## 10.10 Electrification inspection

Connect video cable and control cable to the other equipments; Electrify 24VAC power.

The PTZ carries on self-checking and executes replacement procedure after power-on.

In the process of self-checking, camera will rotate horizontally and slowly for one and half cycle to the default original horizontal point which is set by factory, then upwardly turn to original vertical point, then downwardly to original horizontal point. Lens will be pulled from far focus to near focus to complete self-checking. The whole camera is absolutely steady means PTZ completed self-checking and ready to be controlled. If unstable, please refer to the troubleshooting in the operation manual appendix.

## 11. Maintenance service terms

### 1. Range of warranty

- The product will be maintained free for one year.
- The product will be obtained the free maintenance service if the same malfunction appears again within three months.
- Malfunction of products caused by force majeure (such as war, earthquake, lightning strike and so on ), abuse, non-standard operation, change of construction, non-normal wear or accident are non-free of warranty.
- Please prevent from the damage which is caused by heavy pressure , the fierce vibration and soaks in the process of transportation and storage, which does not belong to the free maintenance scope.
- Please adopt the way of fission package or original package to transport because the product damage dose not belong to the free maintenance scope if you use the whole packing way , not the original packing way.
- The maintenance services will not be free when the pan/tilt module is disassembled or serviced by the user voluntarily.
- Our company implements the lifetime payable service if the product in malfunction has surpassed the warranty period.
- To the products with defect :if it's in the period of warranty, please fill in the form of warranty information correctly, describe the trouble in details, and provide original sales. invoice or its copy.
- For the damage and loss which was caused by the user's specifically application, factory won't bear any risk and responsibility. The factory compensation made by breach of faith, negligence or tortious won't exceed the amount of the products. The factory won't bear any responsibility for the special, unexpected and continue damage caused by any other reasons.
- Our company has the final right of explanation for the above terms.

### 2. Warranty terms

- If the products are within the warranty time, the buyer should fill in the warranty card and send back together with the products.

### 3. Shipping

- If the product needs repaired , you can return it to the manufacturer through the supplier or directly. If you choose the later , please contact us in order to speed up the process. And our company only undertake the one-way freight from manufacturer to customer after maintenance.