

# General Vehicle PTZ Camera User Manual

---

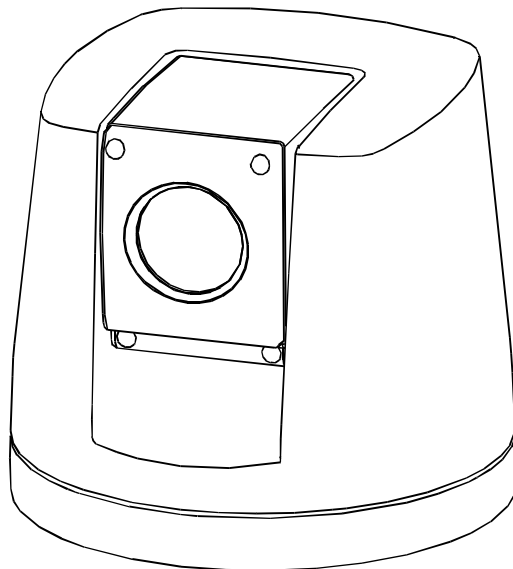

# TABLE OF CONTENT

1. Precaution-----	1
2. Performance-----	2
2.1 Dome parameter-----	2
2.2 Camera parameter-----	2
2.3 Performance & Feature-----	3
3. Function instruction-----	5
3.1 Camera ID-----	5
3.2 Auto-run motion-----	5
3.3 Camera control-----	6
3.4 Monitor function-----	6
4. System setting-----	8
4.1 Basic operation-----	8
4.1.1 Self-testing-----	8
4.1.2 Call the main menu-----	8
4.1.3 Menu and keyboard operation-----	8
4.2 Edit dome label-----	9
4.3 Initial information-----	10
4.4 Display setup-----	11
4.5 System motion control-----	12
4.5.1 Auto flip-----	12
4.5.2 Speed proportion pan-----	12
4.5.3 Park action-----	13
4.5.4 Power up action-----	13
4.5.5 Fan startup by temperature-----	13
4.5.6 Advance setting-----	14
4.6 Clear -----	15
4.7 Password setup-----	16
4.8 Clock setting -----	17
4.9 Dome address -----	18
5. Camera setting-----	19
5.1 Zoom speed-----	19
5.2 Digital zoom control-----	20
5.3 Back light compensation-----	21
5.4 Slow shutter control-----	22
5.5 Line Sync control-----	23
5.6 WDR control-----	23
5.7 IR cut filter-----	24
5.8 Advance setting-----	25
5.8.1 AE mode-----	25

5.8.2 White balance mode-----	26
6. Function setting -----	27
6.1 Preset -----	27
6.2 Scan-----	28
6.3 Pattern-----	29
6.4 Tour-----	30
6.5 Zone-----	31
6.6 Time running-----	32
7. Privacy zone masking-----	33
8. Alarm function -----	34
8.1 Arm setting-----	34
9. Set language -----	36
10. Appendix-----	37
10.1 Menu index-----	37
10.2 RS485 Bus Basic Knowledge-----	38
10.3 DIP switch setup-----	42
10.3.1 Baud rate setting-----	42
10.3.2 Protocol setting-----	42
10.3.3 ID setting-----	42
11.Installation instruction-----	47
11.1 Caution-----	47
11.2 Lightning Proof and Surge Proof-----	48
11.3 Water Proof-----	48
11.4 The preparation of installation-----	48
11.5 Structure introduction-----	49
11.6 Basic size graph-----	49
11.7 Installation -----	50
11.8 Switches setting -----	50
11.9 Cabling connection-----	51
11.10 Electrification inspection-----	51
12.Maintance service terms-----	52

## 1. Precaution

### Ø Electrical safety

Conform to country and local electrical safety standard when using or installing the product.

### Ø Transportation with care

The PTZ should be protected against extremes of pressure, vibration and humidity during storage installation and transportation. The infrared PTZ camera is transported by integrated packing.

### Ø Installation with care

Please refer to user installation manual when installation. Please pick up the Infrared parts gently and do not press it, or else, which will cause the malfunction of parts; the lens of Infrared belong to optional products, please do not touch it by your hand to avoid scraping it.

### Ø Requirements to service personnel

All the service work should be done by qualified technicians.

### Ø Do not disassemble the pan/tilt module

Do not disassemble screws, and don't maintain the parts in the Pan/Tilt by yourself. Only qualified and authorized personnel can undertake repairs.

### Ø Environmental requirements

Environmental temp: -40~+60°C

Humidity: <95%

Air pressure: 86~106Kpa

Power supply: DC12V ± 2V

If users power on the camera under -10°C, for protecting the accessory of the camera, it will start the heating function, and then begin to self-testing. The LCD shows as below:

INITIAL INFO
S/N:8DFS9A100200002
FIRMWARE V1.00
PROTOCOL: FACTORY
DOME ADDRESS: 001
COMM:4800,N,8,1
TEMPERATURE -10°C

### Ø Don't place the camera to be shoot by strong light objects

Don't place the camera to be shoot by strong light objects. Don't point the PTZ to the sun or other bright objects when in use or not. It may affect image quality.

### Ø Function of waterproof

Our product has good water-proof, humidity-proof and dust-proof, which pass the standard of IP66. But it's not good to stay in the humidity environment, which will make some machinery parts broken.

## 2. Performance

### 2.1 Dome parameter

Electrical:		Setting:	
Power supply	DC 12V	Baud rate (RS485)	2400/4800/9600/19200bps
Consumption	25W	Protocol	Sixteen protocols, including PELCO, Kalatel, Philips, Diamond, etc.
Decoder	Built-in	Address setting	0-254
Operation:		Environmental:	
Pan rotation	360° continuously	Operational environment	-40°C ~ +60°C
Tilt rotation	120°	Environmental humidity	0-95% no condensation
Rotation speed	Pan 0.4~80°/s	Protection grade	IP66, Weather proof housing, 4000V lightning proof surge proof
Alarm function	7 alarm input/2 alarm output	Physical:	
Preset	128	Mount	Stand-up mount
Surveillance	Preset, Tour, Scan, Pattern	Net weight	4.8Kg

### 2.2 Camera parameter

SPEC \ TYPE	C :18X Color	D :26X Color/B&W	F :26X Color/B&W	G:26X Color/B&W	M:30X Color/B&W	L:35X Color/B&W	T:30X IR Cut Filter	N: 27X IR Cut Filter	T: 22X IR Cut Filter	
Sync system	PAL/NTSC									
Imaging element	1/4 " Sony Exview HAD CCD						1/4 " Interline Transfer CCD	1/4 " Exview HAD CCD	1/4 " Sony Exv iew HAD CCD	
Scan system	2:1 Interlacing									
Effective Pixel	752(H)×582(V)									
Scan frequency	Pan 15.625KHz/Tilt 50Hz									
Resolution	Color 480TVL B&W 570TVL	Color 530TVL B&W 570TVL	Color 540TVL B&W 570TVL	Color 520TVL B&W 570TVL		Color 520TVL B&W 570TVL	540TVL	570TVL		
Mini Illumination	Color 0.7Lux B&W 0.01Lux		Color 0.05Lux B&W 0.01Lux		Color 0.025Lux B&W 0.01Lux	Color 0.6Lux B&W 0.1Lux	Color 0.003Lux B&W 0.0001Lux	Color 1Lux B&W 0.01Lux		
Magnification	18X optical 12X digital	26X optical 12X digital	36X optical 12X digital	23X optical 12X digital	30X optical 12X digital	35X optical 12X digital	30X optical 10X digital	27X optical 10X digital	22X optical 10X digital	
Zoom length	4.1mm- 73.8mm	3.5mm-91mm	3.4mm- 122.4mm	3.6mm- 82.8mm	3.4mm- 102mm	3.4mm- 119mm	3.4mm to 99mm F1.6 to F3.4	3.25mm to 88mm F1.5 to F3.8	3.9mm-85.8mm F1.6	
View of angle	W48.0° /T2.8°	W54.2° /T2.2°	W57.8° /T1.7°	W54.0° /T2.5°	W55.8° /T2.0°	W55.8° /T1.7°	W58.0° /T2.22°	W55.0° /T2.4°		
Lris	Auto/manual									
Focus	Auto/manual									
White Balance Control	Auto/manual (R/B gain adjustable)									
Back light compensation	Off/Auto									
S/N	≥50dB						≥52dB		≥48dB	
Electronic Shutter	1/1~1/10,000s						1/1~1/120,000s	1/50~1/100,000s	1/50~1/10,000s	
Video output	1.0±0.2V <sub>p-p</sub>									
Video output	Female BNC									
Wide Dynamic Range	N/A	OFF/ON					N/A			
Privacy Zone Masking	24			8			4	8	N/A	

## 2.3 PTZ Performance and feature

The intelligent Pan/tilt was complete new design, compact structure, built-in constant temperature device and rapidly heat dissipation from chip; wiper function can retain full resolution picture in raining day; AMP socket is convenient for installation; Infrared LED range more than 60 meters; Camera rotate flexibly with low noise, wide range capture and certain auto-functions can provide perfect quality of image for customer.

### Ø Built-in decoder

- All configurable options stored in main control board to protect against power cuts
- Integrate design and high durability
- 01-80 preset support auto-tour, and each tour can store up to 24 presets.
- 4 pattern tours
- Built-in direction indicator
- Built-in clock setting function
- Rs485 Bus communication or American Dynamics Manchester code
- Support 24 masking zones at most ( This function is decide by the parameter of built-in camera, if the camera has not this function, this option is invalid. )
- 7 alarm input, 2 alarm output.
- 128 presets can be randomly stored
- 4 scan
- Built-in temperature indicator

### Ø Pan/Tilt Feature

- Aluminum alloy material and anti-violence design surface is well hidden and rapid heat removal. Level of protection achieves IP66.
- Precise stepping motor drives the pan to run smoothly and react sensitively.
- Integrated design, compact structure, easy to disassemble.
- Exquisite mechanical drive, support to rotate pan 360° continuously and tilt -30° ~ +90°
- Pan 0.4° /s to rotate slowly, and the image doesn't vibrate.

### Ø Built-in digital camera

- High sensitivity, high resolution, and integrated digital processing
- Auto-focus
- Auto brightness control
- IR cut filter
- Auto slow shutter
- Auto-Iris
- Auto white balance
- Auto back light compensation

### Ø OSD menu

- All English menu can be selected.
- Visual OSD menu. Revising the PTZ's information and parameter by keyboard and OSD menu, and it is easy to operate.
- Set park action function and set presets, or run scan, pattern, tour, etc during idle time.
- Auto-resume movement or carry out pointed movements after power up.

## Ø Internal temperature test

- Set real time display
- When the temperature exceeds the limit, the screen will display alarm information.
- When the temperature is under the limit, the PTZ will delay to startup, and when the heat device is heated and got higher than low limit temperature to startup.
- According to the temperature, the fan measures if it is to start or not, and prolong the life of fan.

## Ø Time running

By the menu “Time running” , user may set time running function everyday, and set different four actions in four different time in one day, including preset, scan, pattern and tour.

### 3. Function Instruction

This passage mainly describes the main function and general principle of intelligence PTZ, and not refer to the concrete operation methods. Different system platform has different operation methods, generally, should according to the system manufactory's operation manual. Please contact dealer to get necessary information, there are some particular requirements and operations under specific condition.

#### 3.1 Camera ID

There are two 8-bit switch SW1 and SW2 on the commutator, and SW2 is for setting communication baud rate and controlling protocol. (For detail setting, please refer to Appendix DIP switch setting) Besides the factory protocol(FACTORY), the PTZ is compatible with various popular protocols, such as PECLO-D, PECLO-P, SAE, VCL, VICON, PANASONIC, SAMSUNG, DIAMOND, KALATEL, LILIN, PHILIPS, VIDO B02, AD and so on.

Any controlling command must base on the objective camera address, and the camera only answer to the controlling command address which coincide with itself. There are three kinds of camera address:

- Common address: Use camera's switch number to set address 1-8 bits, the address range is 1-254.
- Debug address: (Only factory protocol and PELCO can be set) if camera ID is set 0, user may select any address to control the PTZ.

#### 3.2 Auto-run motion

##### Ø Focus/speed proportion pan

When manually adjusting, for far focus situation, the PTZ responds at a high-speed so that touching rocker slightly may make picture move rapidly, thus cause the picture to lose. To base on humanized design, the PTZ automatically adjust pan and tilt rotation according to zoom near and far, which make it is convenient to operate manually to make tracking for the object. In the menu, you may change system parameter setting proportion pan as ON to run this function.

##### Ø Auto flip

If user holds the joystick in the down position, the camera rotates pan 180 degrees, then the camera rotates tilts up to 120 degrees. In the menu, you may set the system parameter setting AUTO FLIP as ON to run this function.

##### Ø Park action

By the menu “ park time” and “park action” , user may set auto-call preset or run tour, pattern, and scan, etc after pointing a few minutes if the PTZ doesn't run any motions.

##### Ø Power up action

By the menu “ power up action” , after the PTZ powers up or restarts, user may set auto- resume movements before power up and auto- call preset or run tour, pattern, and scan etc .



## 3.3 Camera control

### Ø Magnification control

The user can control “Wide/Tele” to adjust zoom far and near of the image by keyboard controller to obtain panoramic image or close view that you need. The PTZ support digital zoom and optical zoom.

### Ø Focus control

System defaults Auto focus. When the lens changes, camera will auto-adjust focus according to the center of the image to get legible image; user can also manually focus to get desire image by operating keyboard “FAR/NEAR” . When operating keyboard joystick, camera resumes to auto focus.

The camera cannot auto focus in the following status:

- Target is not the center of the image
- Observation the target near and far at the same time, can not be clear at the same time.
- Target is a strong light object, such as neon light, spotlight , etc.
- Target moves too fast
- Target area such as wall
- Target is too dark or vague
- Target image is too small

### Ø Iris control

System defaults Auto Iris. Camera can rapidly adjust size of Iris, through the automatically induct the changing of environment ray, and thus make the brightness of deferent image stable.

User may adjust Iris by controller keyboard “open/close” to get required brightness that you need. User also can resume auto Iris by joystick operation. When controlling the Iris manually, the PTZ locks current position you manually controlled; when operating joystick, the PTZ resume auto Iris.

### Ø Auto back light compensation

Camera sub-area can carry out auto back light compensation. Under a strong light background, camera will auto compensate light for the darker object and adjust daylight to the bright background. In order to avoid making the image lack fidelity by the back line is too bright, and the object is unable to recognize because of darkness, thus gain legible image.

### Ø Auto white balance

Camera can automatically adjust white balance in accordance with the alteration of background lightness to reach a true color.

## 3.4 Monitor function

### Ø Set and call preset

Preset function is that PTZ stores current pan/tilt angle, zoom and other position parameters into the memory. When necessary PTZ recalls these parameters and adjust camera to that position. User can store and recall presets easily and promptly by using keyboard controlling. The PTZ can store up to 128 presets.

### Ø Tour

Auto tour is the built-in function in the PTZ, to make preset arranged in needful order in tour queue by programming in advance. To make camera tour between presets by inserting presets in cruise tour. It is feasible to program tour order, each time as you run tour, you can set the park time of preset. A tour can store 24 presets.

### **Ø Scan**

The operator can promptly set right limit and left limit in advance by keyboard and menu, so as to make the camera repeatedly scanned between right and left limit at a setting speed.

### **Ø Pattern**

Pattern is built-in function in camera; the PTZ can record tracks that are no less than 180s, when running pattern, the PTZ moves repeatedly according to the recorded tracks. A PTZ can set up to 4 pattern tours.

### **Ø Alarm input/output controlling function**

The PTZ receive an external alarm message, to implement the action that you preset, till the alarm release to resume, if abnormality, it will send another alarm message. The PTZ can set up to 7 alarm input and 2 alarm output.

### **Ø Privacy zone masking**

The user can set a black shadow to mask the area so that it will not appear on the monitor to protect privacy. ( This function is relative with the type of the PTZ, if zoom camera hasn't this function, it is invalid).

### **Ø Lens position display**

The position that the PTZ has finished to auto-checking as 0 point of pan movement and tilt movement. The pan range is 0-360° , and tilt range is -30° ~ +90° . According to the displayed information, to set the position of camera lens, and the position can display on the screen.

## 4. System setting

### 4.1 Basic operation

#### 4.1.1 Self-testing

The PTZ conducts self-testing after current-carrying, and it rotates slowly until displaying pan origin that is default setting, then moving to tilt origin, the lens is adjusted from far zoom to near zoom, then from near zoom to far zoom, when self-testing is finished, there is relevant system information displaying on the screen, as follow:

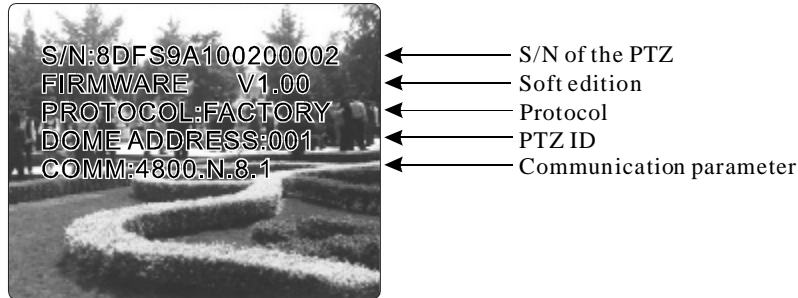

The information will not disappear until you stop to operate the system. If you set “power up action”, the PTZ will automatically activate motions after self-testing. How to operate the function? We will explain detail introduction in following passages.

#### 4.1.2 Call the main menu

The system enters into the main menu by calling 95 preset or by calling 9 preset twice within 3 seconds. All the menu setting must enter into the main menu at first.

#### 4.1.3 Menu and keyboard operation

##### Ø Keyboard operation:

**【OPEN】** when choosing pictures, it means to increase Iris; when setting menu, it means to enter into the next menu or setting, or means to save after setting.

**【CLOSE】** when choosing pictures, it means to reduce Iris; when setting menu, it means to exit without saving setting.

**【NEAR】** Focus to near

**【TELE】** Increase magnification

**【WIDE】** Reduce magnification

Joystick to up: When choosing menu, it means to choose the former one; when choosing picture, it means camera tilt up.

Joystick to down: when choosing menu, it means to choose the next one; when choosing picture, it means camera tilt down.

Joystick to left: when choosing menu, it is equal with **【CLOSE】**, when choosing picture, it means camera tilt left.

Joystick to right: when choosing menu, it is equal with **【OPEN】**, when choosing picture, it means camera tilt right.

Press **【TELE】** and **【WIDE】** at the same time, it means 3D joystick rotates joystick cap.

##### Ø Menu operation

“BACK” : Back to the former menu

“EXIT” : Exit to menu

“ON” : Open some setting

“OFF” : Close some setting

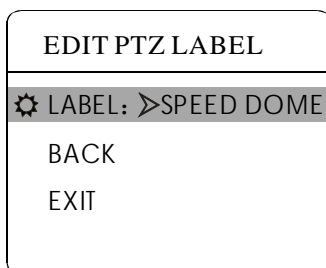
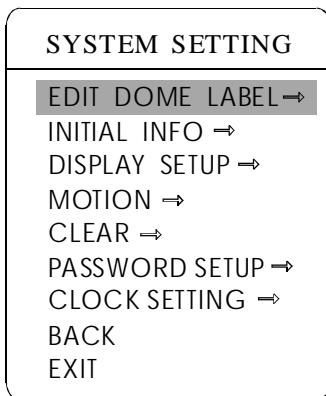
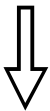
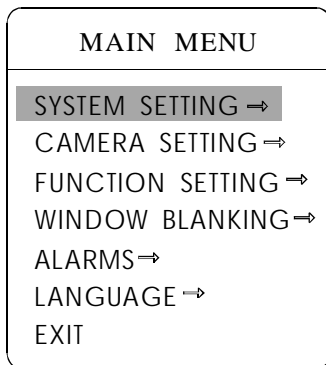

### 4.2 Edit dome label

When using a lot of PTZ, in order to identify each PTZ, the systems support title setting. The setting ways as follow:

1. The system enters into the main menu by calling 95 preset or by calling 9 preset twice within 3 seconds.
2. Operate joystick and move the cursor to **【SYSTEM SETTING】**, and press **【OPEN】** to enter into the next menu.
3. Operate joystick and move the cursor to **【EDIT PTZ LABEL】**, and press **【OPEN】** to enter into the label setting menu.
4. Operate joystick and move the cursor to **【LABEL】**, and press **【OPEN】** to edit current label.
5. When the cursor is twinkling in the first character of the label, to move joystick to choose character, after editing, press **【OPEN】** to save.
6. Moving joystick to **【BACK】** and press **【OPEN】** to back to the former menu.



#### NOTICE

The label may set 16 characters, and doesn't need editing characters. Pressing **【OPEN】** continuously to jump over and using spacebar to replace the deleted characters. When you finish to edit a character, press **【OPEN】** to enter into the next editing character; when you editing the last character, pressing **【OPEN】** to save. Press **【Close】** to exit.

Characters of label available for choosing are as follow: 0-9, A-Z, : <> - ., Space.

The input ways of other labels are the same as above.

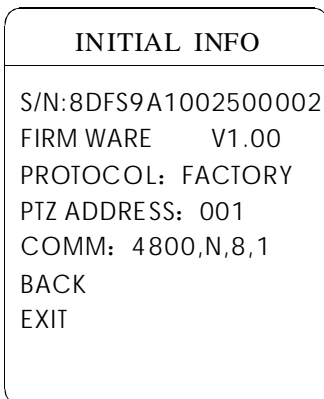
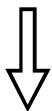
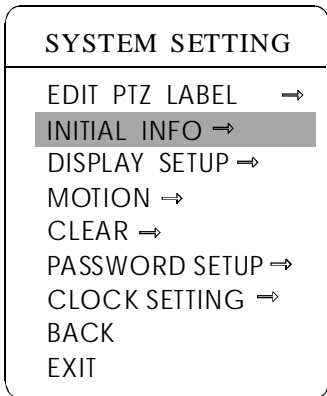
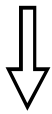
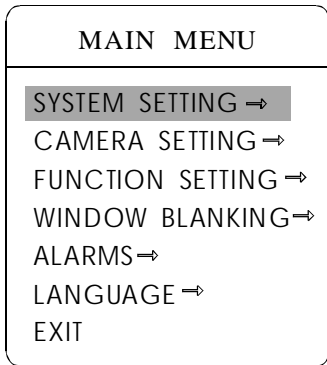

### 4.3 Initial information

1. The system enters into the main menu by calling 95 preset or by calling 9 preset twice within 3 seconds.
2. Operate joystick and move the cursor to **【SYSTEM SETTING】** , press **【OPEN】** to enter submenu.
3. Operate joystick and move the cursor to **【INITIAL INFO】** , press **【OPEN】** to display initial information as below the left picture.

Initial information includes S/N of the PTZ, software edition, Protocol, PTZ ID, communication parameter. System setting may change the numerical value of initial information.

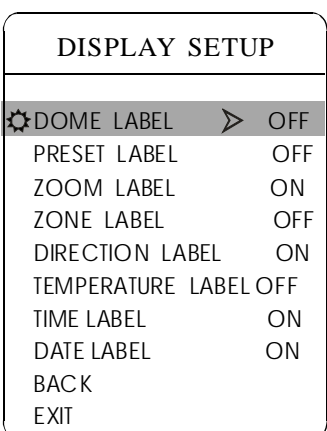
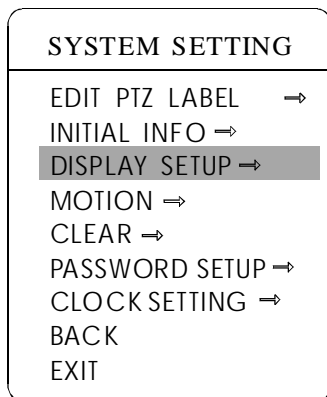
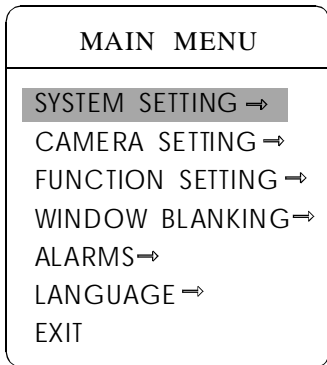

## 4.4 Display setup

1. The system enters into the main menu by calling 95 preset or by calling 9 preset twice within 3 seconds.

2. Operate joystick and move the cursor to **【SYSTEM SETTING】**, press **【OPEN】** to enter submenu.

3. Operate joystick and move the cursor to **【DISPLAY SETUP】**, press **【OPEN】** to enter “display setup” menu, May setting the content of the display setup as follow:

- **【DOME LABEL】**
- **【PRESET LABEL】**
- **【ZOOM LABEL】**
- **【ZONE LABEL】**
- **【DIRECTION LABEL】**
- **【TEMPERATURE LABEL】**
- **【TIME LABEL】**
- **【DATE LABEL】**

4. Taking display PTZ label as an example to explain the operation process  
Tilt up/down joystick to move cursor to **【Dome LABEL OFF】**, press **【OPEN】**, there is a sign “⚙️” besides **【Dome LABEL】**, the cursor is twinkling besides **【OFF】**, as left picture shows;

5. Operate joystick, setting number changes between ON/OFF, when setting **【ON】**, it means to display “PTZ label”; when setting **【OFF】**, it means not to display “PTZ label”. when pressing **【OPEN】**, the cursor jump back in front of **【DOME LABEL】**, means label setting is finished, when moving the cursor to **【EXIT】**, it means exiting the menu setting.

The displaying information on the screen will change with the PTZ rotation; Through the information on the screen, user can see current PTZ inside temperature, magnification, display zone etc. When all the label are displayed, the PTZ works as the following picture shows,:

(In the picture “305” means pan angle, “45” means tilt angle.)

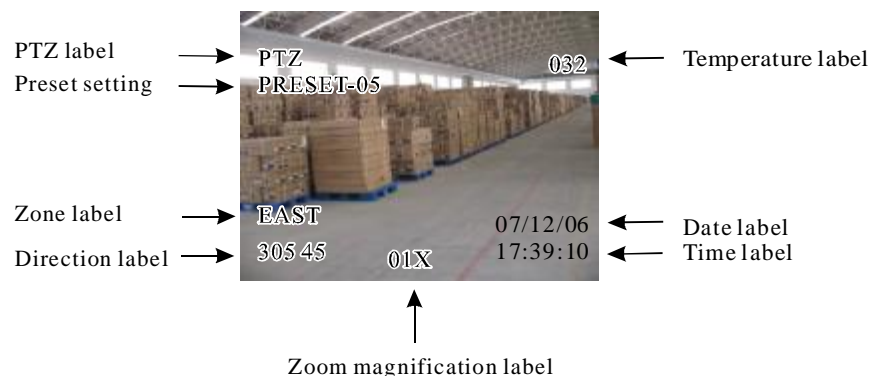

SYSTEM SETTING	
EDIT PTZ LABEL	→
INITIAL INFO	→
DISPLAY SETUP	→
<b>MOTION</b>	<b>→</b>
CLEAR	→
PASSWORD SETUP	→
CLOCK SETTING	→
BACK	
EXIT	



MOTION	
 AUTO FLIP	ON
PROPORTION PAN	ON
PARK TIME	005
PARK ACTION	SCAN
POWER UP ACTION	AUTO
FAN ENABLED	045C
TEMP C/F	CENT
ADVANCE SETTING	→
BACK	
EXIT	



MOTION	
AUTO FLIP	ON
 PROPORTION PAN	ON
PARK TIME	005
PARK ACTION	SCAN
POWER UP ACTION	AUTO
FAN ENABLED	045C
TEMP C/F	CENT
ADVANCE SETTING	→
BACK	
EXIT	

## 4.5 Systematic motion control

Systematic motion controlling may control a series of canonical movement of the PTZ, and play an important role in controlling the PTZ.

1. The system enters into the main menu by calling 95 preset or by calling 9 preset twice within 3 seconds.
2. Operate joystick and move the cursor to **【SYSTEM SETTING】**, press **【OPEN】** to enter submenu.
3. Operate joystick and move the cursor to **【MOTION】**, press **【OPEN】** to enter systematic motion controlling menu, as left picture shows.

### 4.5.1 Auto flip

1. Operate joystick and move the cursor to **【AUTO FLIP】**: press **【OPEN】** to enter “ auto flip ” setting, tilt up/down joystick, for example: choosing "ON" to open “ auto flip ” ; choosing "OFF" to close “auto flip” .

Press **【OPEN】** to save.

**REMARK:** When opening the auto flip function, user holds the joystick in the down position, the camera rotates pan 180 degrees, after the camera rotates tilt up to 180 degrees.

### 4.5.2 Speed proportion pan

- Operate joystick and move the cursor to **【PROPORTIONAL PAN】**. Press **【OPEN】** to enter “ proportion pan ” setting, tilt up/down joystick to choose, if choosing **【ON】**, it means to open proportion pan; if choosing **【OFF】**, it means to close proportion pan, press **【OPEN】** to save.

#### OPERATION KNACKS

When manually adjusting, for far focus situation, the PTZ responds at a high-speed so that touching joystick slightly may make picture move rapidly, thus cause the picture to lose. To base on humanized design, the PTZ automatically adjust pan and tilt rotation according to zoom near and far, which make it is convenient to operate manually run after object.

MOTION	
AUTO FLIP	ON
PROPORTION PAN	ON
PARK TIME	005
⚙️ PARK ACTION	➤ SCAN
POWER UP ACTION	AUTO
FAN ENABLED	050C
TEMP C/F	CENT
ADVANCE SETTING	➔
BACK	
EXIT	

### 4.5.3 Park action

This setting allows the PTZ to run an appointed action after it enters vacancy for a few time (1-240minutes). If default sets as 0, it means not to run this action automatically.

1. Operate joystick and move the cursor to **【PARK TIME】**, press **【OPEN】** to tilt up/down joystick to set park time, the range is 0-240 (minute), press **【OPEN】** to save. **【PARK ACTON】** is running action at park time, when **【PARK TIME】** sets as 0, this item can't be set.

2. Operate joystick and move the cursor to **【PARK ACTON】**, press **【OPEN】** there will be a sign ⚙️ in the front of **【PARK ACTON】**, the cursor jump to right, after tilt up/down joystick to choose “ park action”, there are options for choosing as follow, press **【OPEN】** to save.

- **【NONE】** - (default) none action
- **【PRESET】** -use preset 1-80
- **【SCAN】** -run scan
- **【PAT1】** - run pattern X
- **【TOUR】** - run tour

MOTION	
AUTO FLIP	ON
PROPORTION PAN	ON
PARK TIME	000
PARK ACTION	NONE
⚙️ POWER UP ACTION	NONE
FAN ENABLED	050C
TEMP C/F	CENT
ADVANCE SETTING	➔
BACK	
EXIT	

### 4.5.4 Power up action

The PTZ start to run actions after self-testing, if nobody intervenes it, it will repeatedly run this action continuously, if default sets as **【NONE】**.

Operate joystick and move the cursor to **【POWER UP ACTION】**: press **【OPEN】** to jump to the following choice, tilt up/down joystick to choose “power up action”, press **【OPEN】** to save.

- **【NONE】** - none action
- **【AUTO】** - the PTZ resumes the primary action and direction

before power up.

- **【PRESET】** - use preset 1
- **【SCAN】** - run scan
- **【PAT1】** - run pattern
- **【TOUR】** - run tour

MOTION	
AUTO FLIP	ON
PROPORTION PAN	ON
PARK TIME	005
PARK ACTION	NONE
POWER UP ACTION	NONE
⚙️ FAN ENABLED	➤ 045C
TEMP C/F	CENT
ADVANCE SETTING	➔
BACK	
EXIT	

### 4.5.5 Fan startup by temperature

The temperature of the PTZ will rise when it is in high temperature. The fan will open automatically when the temperature reaches to a very high degree value in order to make sure the stability of the PTZ.

Operate joystick, move the cursor to **【FAN ENABLED】**: press **【OPEN】**, the cursor will skip to the back option. The user can choose the fan to start up temperature, and press **【OPEN】** to save it in actual condition.

The default setting temperature of the fan startup is 40°C. The user also can enter into the fan startup setting to adjust the temperature of fan startup. As picture shows: the temperature range is 0-60°C. **【TEMP】** can switch the temperature between Fahrenheit and Centigrade.



MOTION	
AUTO FLIP	ON
PROPORTION PAN	ON
PARK TIME	005
PARK ACTION	SCAN1
POWER UP ACTION	AUTO
FAN ENABLED	050C
TEMP	CENT
ADVANCE SETTING	→
BACK	
EXIT	



ADVANCE SETTING	
EIS ENABLED	N/A
PRESET FREEZE	OFF
HEAD-DOWN	OFF
DEFOGGER	015C
A D J SPEED	100
BACK	
EXIT	

## 4.5.6 Advanced setting

Operate joystick and move to **【ADVANCE SETTING】**, press **【OPEN】** to enter into "advance setting";

**【EIS ENABLED】** : Electronic Image Stabilizer function;

**【PRESET FREEZE】** : Means the image will be frozen at the point that you call the new preset, until the camera totally gets the new preset, the frozen image can be released.

**【HEAD-DOWN】** : Settings of Top/Down. "ON" means DOWN, "OFF" means TOP.

**【DEFOGGER】** : Lens of PTZ will be fogged when PTZ works in quite cold temperature. In order to get clear image, defogger will open automatically at the appointed temperature. Choosing **【DEFOGGER】** by operating the joystick, and press **【OPEN】**, then cursor leap to the optional. Choose the temperature to run the defogger, and press **【OPEN】** to save. Range of Temperature: 0~30°C.

**【ADJ SPEED】** : The rotation percentage of P/T, 100 means factory speed, 80 means 80% of factory speed.

### OPERATION KNACKS

1. After the PTZ set the EIS function, if the PTZ wobble slight when running, the camera will shield the wobble picture and make the picture calm and smooth.
2. When start-up preset freeze, it can not only totally eliminate the flash imaging in calling preset point but also reduce the Video's size, and thus save memory space for DVR.



**NOTICE**

These function in the advance setting menu depends on the models and parameters of built-in camera in PTZ, if the camera haven't this function, then this function is invalid. The option is useless (N/A) when the camera module has no such function.

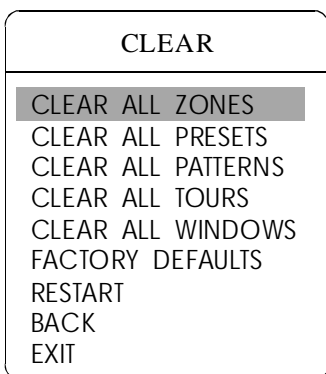
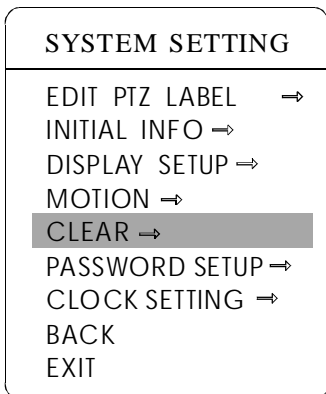
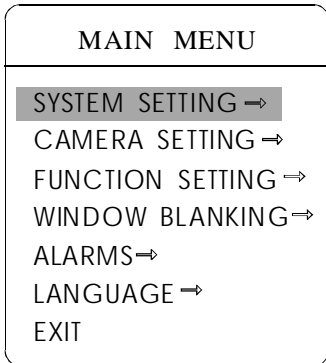

## 4.6 Clear

1. The system enters into the main menu by calling 95 preset or by calling 9 preset twice within 3 seconds.
2. Operate joystick and move the cursor to **【SYSTEM SETTING】**, press **【OPEN】** to enter submenu.
3. Operate joystick and move the cursor to **【CLEAR】**, press **【OPEN】** to enter submenu, as left picture shows.
  - **【CLEAR ALL ZONES】**
  - **【CLEAR ALL PRESETS】**
  - **【CLEAR ALL PATTERNS】**
  - **【CLEAR ALL TOURS】**
  - **【CLEAR ALL WINDOWS】**
  - **【FACTORY DEFAULTS】** :resume the factory default. Run this function, the camera parameter and system parameter will resume to factory default, clear all windows and alarm setting. Please be cautious to use this function.
  - **【RESTART】**
4. Set clear zone as an example to explain the process. Move joystick to **【CLEAR ALL ZONES】**, press **【OPEN】** to clear all zones.

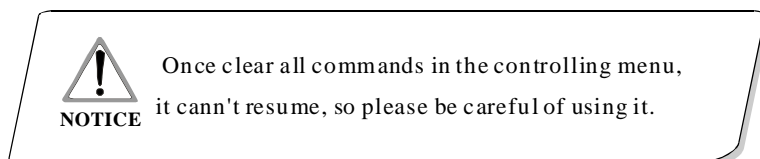

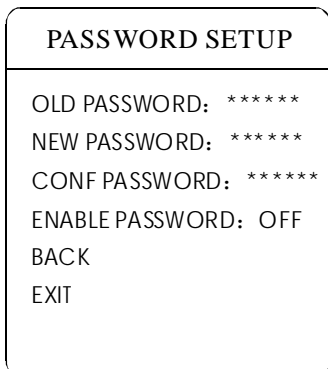
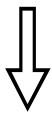
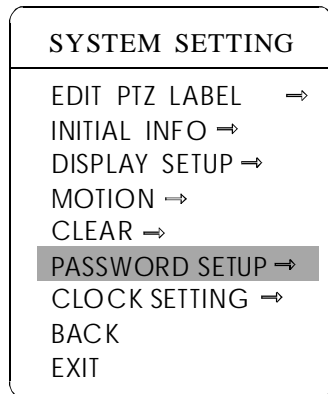
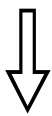
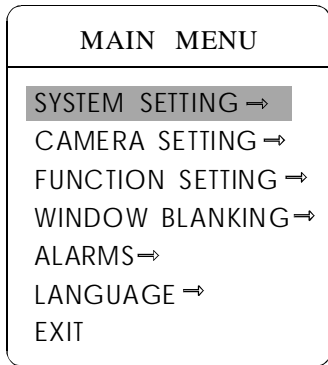

## 4.7 Password setup

1. The system enters into the main menu by calling 95 preset or by calling 9 preset twice within 3 seconds.
2. Operate joystick and move the cursor to **【SYSTEM SETTING】** , press **【OPEN】** to call the submenu.
3. Operate joystick and move the cursor to **【PASSWORD SETUP】** , press **【OPEN】** to call the submenu. Please refer to the left picture.
4. Operate joystick and move the cursor to **【OLD PASSWORD】** , press **【OPEN】** to choose it, operate the joystick right and left to input the password, up and down to choose the number which you need.

- **【NEW PASSWORD】** Enter the new password
- **【CONFIRM PASSWORD】** Confirm the new password
- **【ENABLE PASSWORD】** Set PASSWORD ON/OFF

(The password function is noneffective under the PASSWORD OFF.) It means that users can enter into the main menu without password. (The password function is effective under the password ON.) It means that user enter into the main menu with password.



### NOTICE

When user forgot the password and can not enter into the main menu, he can use the super password to enter ,which is "892226", At this time ,the password of PTZ will change to initial one, which is "000000",and then user may set the password by himself again.

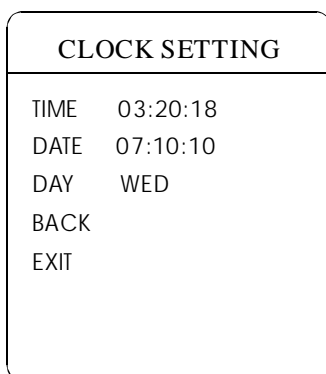
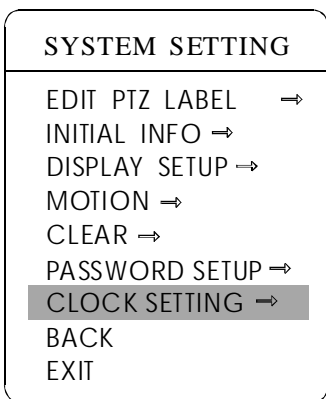
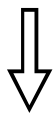
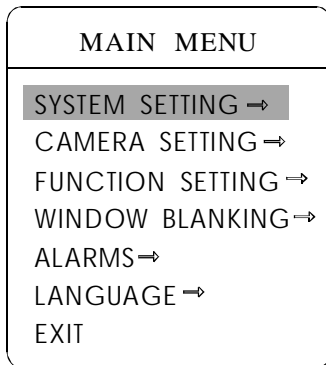

### 4.8 Clock setting

1. The system enters into the main menu by calling 95 preset or by calling 9 preset twice within 3 seconds.

2. Operate joystick and move the cursor to **【SYSTEM SETTING】**, press **【OPEN】** to call the submenu.

3. Operate joystick and move the cursor to **【CLOCK SETTING】**, press **【OPEN】** to call the submenu. Please refer to the left picture.

4. Operate joystick and move the cursor to **【TIME】**, press **【OPEN】** to choose it, move the joystick up and down to choose the number you need, left and right to set hour, minute and second.

- **【TIME】** set hour, minute, second
- **【DATE】** set year, month, date
- **【DAY】** set week

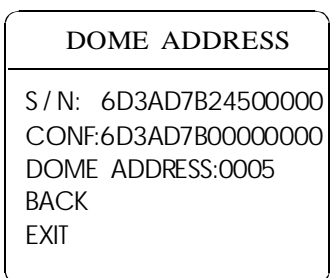
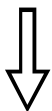
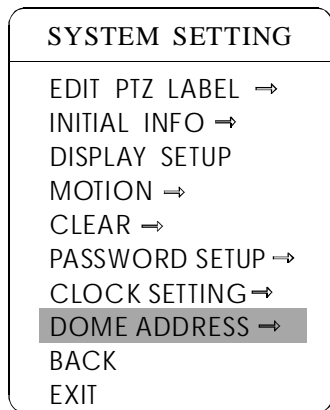
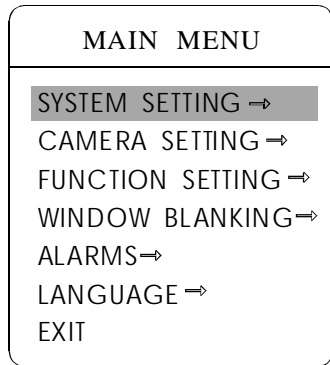

## 4.9 Dome Address Setting

1. The system enters into the main menu by calling 95 preset or by calling 9 preset twice within 3 seconds.
2. Operate joystick and move the cursor to **【SYSTEM SETTING】**, press **【OPEN】** to enter submenu.
3. Operate joystick and move the cursor to **【DOME ADDRESS】**, press **【OPEN】** to call dome parameter setting menu

**S/N**: Series No. of the dome

**CONF**: Confirm S/N and input the same NO. with S/N

**DOME ADDRESS**: Set dome address (ID range: 001-255)



**NOTICE**

1. If **【S/N】** and **【CONF】** are different, the above operation can't be implemented.
2. The PTZ address should be set as 255 (mean set Switch 1 as ON), there will be display this item **【PTZ ADDRESS】**
3. After setting PTZ address, the PTZ need to restart, then the PTZ address will be effective.

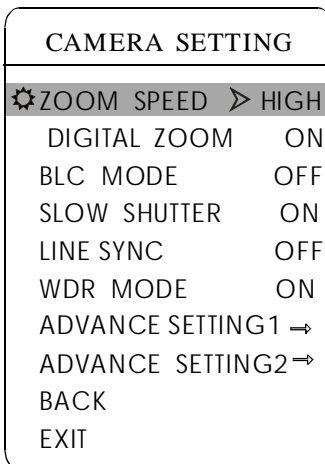
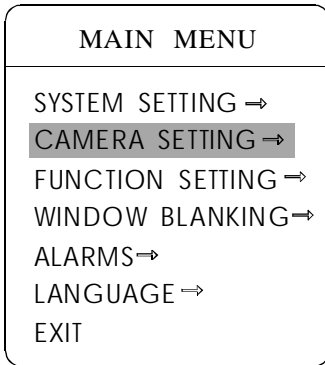

## 5. Camera setting

### 5.1 Zoom speed

1. The system enters into the main menu by calling 95 preset or by calling 9 preset twice within 3 seconds.
2. Operate joystick and move the cursor to **【CAMERA SETTING】** , press **【OPEN】** to enter submenu;
3. Operate joystick and move the cursor to **【ZOOM SPEED】** ; press **【OPEN】** will appear a sign "⚙️" in the front of **【ZOOM SPEED】** , the cursor moves to right, tilt up/down joystick to choose **【HIGH】** or **【LOW】** ;
4. Press **【OPEN】** to save, press **【CLOSE】** to cancel.

MAIN MENU	
SYSTEM SETTING →	
<b>CAMERA SETTING →</b>	
FUNCTION SETTING →	
WINDOW BLANKING →	
ALARMS →	
LANGUAGE →	
EXIT	



CAMERA SETTING	
ZOOM SPEED	HIGH
<b>⚙️ DIGITAL ZOOM</b>	<b>➤ ON</b>
BLC MODE	OFF
SLOW SHUTTER	ON
LINE SYNC	N/A
WDR MODE	ON
ADVANCE SETTING1 →	
ADVANCE SETTING2 →	
BACK	
EXIT	

## 5.2 Digital zoom control

1. The system enters into the main menu by calling 95 preset or by calling 9 preset twice within 3 seconds.
2. Operate joystick and move the cursor to **【CAMERA SETTING】** , press **【OPEN】** to enter camera setting;
3. Operate joystick and move the cursor to **【DIGITAL ZOOM】** , press **【OPEN】** to enter digital zoom setting, move the cursor to choose ON means open digital zoom control which is digital zoom is pulled near, if pulling the digital zoom near again, the PTZ enters into “ digital zoom increase” ; to choose OFF means to close digital zoom control.
4. Press **【OPEN】** to save.

### OPERATION KNACKS

When digital zoom be set as ON, the maximum zoom magnification of the PTZ is digital zoom magnification times optical zoom magnification; when digital zoom be set as OFF, the maximum zoom magnification of the PTZ is optical zoom magnification.



**NOTICE**

This function depends on the models and parameters of built-in camera in PTZ, if the camera haven't this function, then this function is invalid.

MAIN MENU	
SYSTEM SETTING →	
<b>CAMERA SETTING →</b>	
FUNCTION SETTING →	
WINDOW BLANKING →	
ALARMS →	
LANGUAGE →	
EXIT	



CAMERA SETTING	
ZOOM SPEED	HIGH
DIGITAL ZOOM	ON
<b>⚙️ BLC MODE</b>	<b>➤ OFF</b>
SLOW SHUTTER	ON
LINE SYNC	OFF
WDR MODE	ON
ADVANCE SETTING1 →	
ADVANCE SETTING2 →	
BACK	
EXIT	

## 5.3 Back light compensation

1. The system enters into the main menu by calling 95 preset or by calling 9 preset twice within 3 seconds.
2. Operate joystick and move the cursor to **【CAMERA SETTING】** to enter submenu.
3. Operate joystick and move the cursor to **【BLC MODE】**, press **【OPEN】**, There will be a sign ⚙️ in the front of **【BLC MODE】**, the cursor jump to right, tilt joystick to open or close back light compensation function. If choosing ON means to open back light compensation mode; if choosing OFF means to close back light compensation mode;
4. Press **【OPEN】** to save.

### OPERATION KNACKS

Strong background ray can make backlighting objects engender shadow, (back light compensation), the PTZ can auto-adjust iris to match with the changes of various ray, and auto-revise the main lightness to make the pictures more legible.



**NOTICE**

This function relates to models and parameters of the built-in camera in the PTZ, when open black compensation, it has two functions which are auto-adjust (when you choose ON) or manual adjust(0-255) according to the different of the camera.



Non-use back light compensation, in strong sunshine, the back light side is subject to dark.



Use back light compensation, the image is in gear.



MAIN MENU	
SYSTEM SETTING →	
<b>CAMERA SETTING →</b>	
FUNCTION SETTING →	
WINDOW BLANKING →	
ALARMS →	
LANGUAGE →	
EXIT	



CAMERA SETTING	
ZOOM SPEED	HIGH
DIGITAL ZOOM	ON
BLC MODE	OFF
<b>⚙ SLOW SHUTTER &gt;</b>	<b>ON</b>
LINE SYNC	OFF
WDR MODE	ON
ADVANCE SETTING1 →	
ADVANCE SETTING2 →	
BACK	
EXIT	

## 5.4 Slow shutter control

1. The system enters into the main menu by calling 95 preset or by calling 9 preset twice within 3 seconds.
2. Operate joystick and move the cursor to **【CAMERA SETTING】** to enter submenu.
3. Operate joystick and move the cursor to **【SLOW SHUTTER】**, press **【OPEN】**, there will be a sign  in the front of **【SLOW SHUTTER】**, the cursor moves to right, tilt up/down joystick to “slow shutter” choice, if choosing ON means to open slow shutter function, if choosing OFF means close “slow shutter” function.
4. Press **【OPEN】** to save.

### OPERATION KNACKS

When the PTZ monitors at night or dark environment, because the ray is not enough, the image on the screen is very dark, setting slow shutter can lengthen the time of lighting so that make the picture shooted in dark more legible.



#### NOTICE

This function depends on the models and parameters of built-in camera in PTZ, if the camera haven't this function, then this function is invalid.

MAIN MENU	
SYSTEM SETTING →	
<b>CAMERA SETTING →</b>	
FUNCTION SETTING →	
WINDOW BLANKING →	
ALARMS →	
LANGUAGE →	
EXIT	



CAMERA SETTING	
ZOOM SPEED	HIGH
DIGITAL ZOOM	ON
BLC MODE	OFF
SLOW SHUTTER	ON
<b>LINE SYNC</b>	<b>OFF</b>
WDR MODE	ON
ADVANCE SETTING1 →	
ADVANCE SETTING2 →	
BACK	
EXIT	

CAMERA SETTING	
ZOOM SPEED	HIGH
DIGITAL ZOOM	ON
BLC MODE	OFF
SLOW SHUTTER	ON
LINE SYNC	OFF
<b>WDR MODE</b>	<b>ON</b>
ADVANCE SETTING1 →	
ADVANCE SETTING2 →	
BACK	
EXIT	

## 5.5 Line sync control

1. The system enters into the main menu by calling 95 preset or by calling 9 preset twice within 3 seconds.
2. Operate joystick and move the cursor to **【CAMERA SETTING】**, press **【OPEN】** to enter submenu.
3. Operate joystick and move the cursor to **【LINE SYNC】**; press **【OPEN】**, tilt up/down joystick to set line sync. Line sync can divide two kinds: internal/external, choose OFF is internal sync; choose ON is external sync; press **【OPEN】** to save.

### OPERATION KNACKS

When a lot of PTZs use a line in the same time, if the image is twinkling as switching, please set each PTZ as external line and adjust the numerical value of external line.



**NOTICE**

This function is relative with the model and parameter of the camera module which insert in the PTZ. The option is useless(N/A) when the camera module has no such function.

## 5.6 WDR Control

1. Operate joystick, move the cursor to **【WDR MODE】**, press **【OPEN】**, tilt up/down joystick to set WDR; Choose ON means open WDR, choose OFF means close WDR, Press **【OPEN】** to save.

**【WDR MODE】**: WDR is the function that features of image can be captured clearly by camera while the picture was cover with strong contrast background. For example: you can enable WDR function to sublime image quality when the two areas A and B exist simultaneously,

A: High Intensity area under strong light exposure (source from daylight, lamp and so on), B: Low luminance area, like shadow, backlighting zone and so on.



**NOTICE**

This function is relative with the model and parameter of the camera module which insert in the PTZ. The option is useless(N/A) when the camera module has no such function.

MAIN MENU	
SYSTEM SETTING →	
<b>CAMERA SETTING →</b>	
FUNCTION SETTING →	
WINDOW BLANKING →	
ALARMS →	
LANGUAGE →	
EXIT	



CAMERA SETTING	
ZOOM SPEED	HIGH
DIGITAL ZOOM	ON
BLC MODE	OFF
SLOW SHUTTER	ON
LINE SYNC	OFF
WDR MODE	ON
<b>ADVANCE SETTING1 →</b>	
ADVANCE SETTING2 →	
BACK	
EXIT	



ADVANCE SETTING 1	
IR CUT FILTER	AUTO
IR CUT ON TIME	N/A
IR CUT OFF TIME	N/A
THRESHOLD	10dB
FLIP	OFF
MIRROR	OFF
MAX GAIN	08dB
EXPOSURECOMP	OFF
SHARPNESS	10
BACK	
EXIT	

## 5.7 IR cut filter

1. The system enters into the main menu by calling 95 preset or by calling 9 preset twice within 3 seconds.

2. Operate joystick and move the cursor to **【CAMERA SETTING】** to enter submenu.

3. Operate joystick and move the cursor to **【ADVANCE SETTING1】**; press **【OPEN】**, there will be a sign  in the front of **【ADVANCE SETTING1】**, the cursor jumps to right, move joystick to “IR cut filter”, choices as follow, **【AUTO】** is default.

- **【AUTO】** IR cut filter mode, it means the PTZ automatically transfers according to sensitivity.
- **【COLOR】** set as color mode
- **【BLACK】** set as black and white mode
- **【TIME】** set ON time and OFF time of black and white mode

When user choose **【TIME】**, **【IR CUT ON TIME】** and **【IR CUT OFF TIME】** will be effective. User may set ON time and OFF time of black and white mode, as follow:

(1) Operate joystick, move the cursor to **【IR CUT FILTER】**, tilt up/down joystick to choose **【TIME】** mode, press **【OPEN】** to save;

(2) Operate joystick, move the cursor to **【IR CUT FILTER】**, tilt up/down joystick to set the beginning time of black and white mode; move joystick to **【IR CUT OFF TIME】** to set the finish time of black and white mode, the same as setting the beginning time; **【FLIP】**: 180° inversion imaging function of image, **【MIRROR】**: image mirroring function.

(3) Operate the joystick and move the cursor to **【MAX GAIN】** which is the max limits of automatic gain and ranges from 8 to 28dB. As the ray is dark, the more smaller value of **【MAX GAIN】**, the more darker, the noise of image is less; The more bigger value of **【MAX GAIN】**, the more brighter, but the noise of image is much.

- **【THRESHOLD】**: sensitive of IR cut filter, the range from 0 to 28dB.
- **【EXPOSURECOMP】**: exposure compensation function.
- **【OFF SHARPNESS】**: sharpness of the image

4. Press **【OPEN】** to save.

### OPERATION KNACKS

IR cut filter function uses color in day; use black and white at night. This function not only guarantees the quality of image, but also saves the room of storage.



**NOTICE**

This function depends on the models and parameters of built-in camera in PTZ, if the camera haven't this function, then this function is invalid.(N/A)

MAIN MENU	
SYSTEM SETTING →	
<b>CAMERA SETTING →</b>	
FUNCTION SETTING →	
WINDOW BLANKING →	
ALARMS →	
LANGUAGE →	
EXIT	

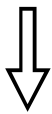

CAMERA SETTING	
ZOOM SPEED	HIGH
DIGITAL ZOOM	ON
BLC MODE	OFF
SLOW SHUTTER	ON
LINE SYNC	OFF
WDR MODE	ON
ADVANCE SETTING1 →	
<b>ADVANCE SETTING2 →</b>	
BACK	
EXIT	



ADVANCE SETTING2	
<b>⚙️ AE MODE</b>	<b>➤ AUTO</b>
SHUTTER	N/A
IRIS	N/A
BRIGHT	N/A
BW MODE	AUTO
R GAIN	N/A
B GAIN	N/A
HI-RESOLUTION	ON
BACK	
EXIT	

## 5.8 Advance setting

1. The system enters into the main menu by calling 95 preset or by calling 9 preset twice within 3 seconds.
2. Operate joystick and move the cursor to **【CAMERA SETTING】** to enter submenu.
3. Operate joystick and move the cursor to **【ADVANCE SETTING2】**; press **【OPEN】** to enter submenu, as left picture shows;

### 5.8.1 AE mode

1. Operate joystick and move the cursor to **【AE MODE】**, press **【OPEN】**, tilt up/down joystick to choose AE mode, modes for choosing as follow:
  - **【AUTO】**: default setting, auto Iris mode
  - **【BRIGHT】**: brightness priority mode
  - **【IRIS】**: iris priority mode
  - **【SHUTTER】**: shutter priority mode
2. Choose Iris priority mode **【IRIS】**, press **【OPEN】** to save.
3. Move joystick to the sub-choices of AE mode **【IRIS F1.4】**, press **【OPEN】** to choose adequate Iris, press **【OPEN】** to save.
  - **【SHUTTER 1/50】** it means shutter speed, when AE mode is shutter priority, this function can be set.
  - **【IRIS F1.4】** it means the size of iris, when AE mode is iris priority, this function can be set.
  - **【BRIGHT F2.0/ODB】** it means brightness, when AE mode is brightness priority, this function can be set.

#### OPERATION KNACKS

Quality of photo relates to exposure amount, that is to say how much light can make CCD receives legible image. Exposure amount is relative to the time of lighten (be up to shutter speed) and the area of lighten (be up to the size of iris).



**NOTICE**

These functions in the advance setting depend on the models and parameters of built-in camera in PTZ, the contents may vary based on different camera module type.

MAIN MENU	
SYSTEM SETTING →	
<b>CAMERA SETTING →</b>	
FUNCTION SETTING →	
WINDOW BLANKING →	
ALARMS →	
LANGUAGE →	
EXIT	



CAMERA SETTING	
ZOOM SPEED	HIGH
DIGITAL ZOOM	ON
BLC MODE	OFF
SLOW SHUTTER	ON
LINE SYNC	OFF
WDR MODE	ON
ADVANCE SETTING1 →	
<b>ADVANCE SETTING2 →</b>	
BACK	
EXIT	



ADVANCE SETTING2	
AE MODE	AUTO
SHUTTER	N/A
IRIS	N/A
BRIGHT	N/A
<b>⚙️ BW MODE &gt;</b>	<b>AUTO</b>
R GAIN	N/A
B GAIN	N/A
HI-RESOLUTION	ON
BACK	
EXIT	

## 5.8.2 White balance mode

System supports **【AUTO】** , indoor mode **【INDOOR】** , outdoor mode **【OUTDOOR】** , auto track mode **【ATW】** , single mode **【OPW】** , **【OPT】** mode, manual mode **【MANUAL】** and kinds of white balance modes, etc. Detail setting as follow:

1. The system enters into the main menu by calling 95 preset or by calling 9 preset twice within 3 seconds. click each command enter into “ advanced setting2” menu according to the order in left picture .

2. Operate joystick and move the cursor to **【BW MODE】** to choose white balance mode, press **【OPEN】** to save.

Auto mode **【AUTO】** is the default mode of speed PTZ, which is auto-revert real color after the white balance sensor check the environment by camera. When choosing manual mode **【MANUAL】** , adjust the numerical value of **【R GAIN】** and **【B GAIN】** .

- **【R GAIN】** the range is 1-255; the numerical value is bigger, it means that adding red is more, the tone changes to be warm.
- **【B GAIN】** the range is 1-255; the numerical value is bigger, it means that adding green is more, the tone changes to be cold.

Indoor mode **【INDOOR】** , and the tone leans to cold.

Outdoor mode **【OUTDOOR】** , and the tone leans to warm.

**【HI-RESOLUTION】** high resolution is built-in function of camera ,This function is relative with the model of camera.



**NOTICE**

It is possible that different camera has not the setting of **【INDOOR】** , **【OUTDOOR】** , **【HI-RESOLUTION】** ; That means the current camera has no such function when the setting option shows N/A.

## 6. Function setting

### 6.1 Preset

1. The system enters into the main menu by calling 95 preset or by calling 9 preset twice within 3 seconds. Click each command to enter “ preset menu” according to the order of the left picture. As following:

- **【PRESET NUMBER】**
- **【SET PRESET】**
- **【SHOW PRESET】**
- **【CLEAR PRESET】**
- **【EDIT PRESET LABEL】**

Define preset and call preset function can be set by keyboard operation, input preset number at first, then click the key “save /call preset” to carry out.

2. Define current preset number: move the cursor to **【PRESET NUMBER】** , press **【OPEN】** to choose preset number, the range is 01-128 as the left picture show, here chooses number 5 as current preset, the following operations aim at the current preset.

3. Define current preset: move the cursor to **【SET PRESET】** , press **【OPEN】** , by operating joystick to adjust magnification, to choose good objective image, press **【OPEN】** to save. If the image is very near, the image is belong in digital zoom; when setting preset, the image will jump to maximal optical zoom.

#### OPERATION KNACKS

Preset function is that PTZ stores current pan/tilt angle, zoom and other position parameters into the memory. When necessary PTZ recalls these parameters and adjust camera to that position.

4. Display current preset: move the cursor to **【SHOW PRESET】** , press **【OPEN】** , the screen will display the current preset;

5. Clear current preset: move the cursor to **【CLEAR PRESET】** , press **【OPEN】** , the current preset is cleared.

6. Edit current preset label: move the cursor to **【EDIT PRESET LABEL】** , press **【OPEN】** to enter into editing preset submenu, system auto-sets label as PRESET-XX, press **【OPEN】** to revise label.

1. When running to program, display, clear preset and edit label, should choose preset number at first.

2. The label may set up to 16 characters, and doesn't need editing characters. Press **【OPEN】** continuously to jump over and use spacebar to replace the deleted characters.

When you finish to edit a character, press **【OPEN】** to enter into the next editing character;

when you finish to edit the last character, pressing **【OPEN】** to save. Press **【CLOSE】** to exit. Character of label is suitable for choosing as follow: 0-9、A-Z、:;<>-. , space.



**NOTICE**

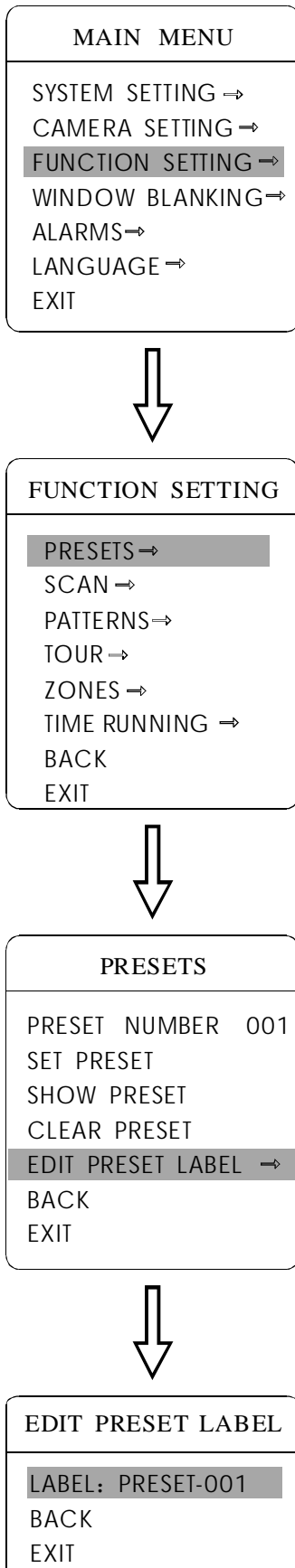

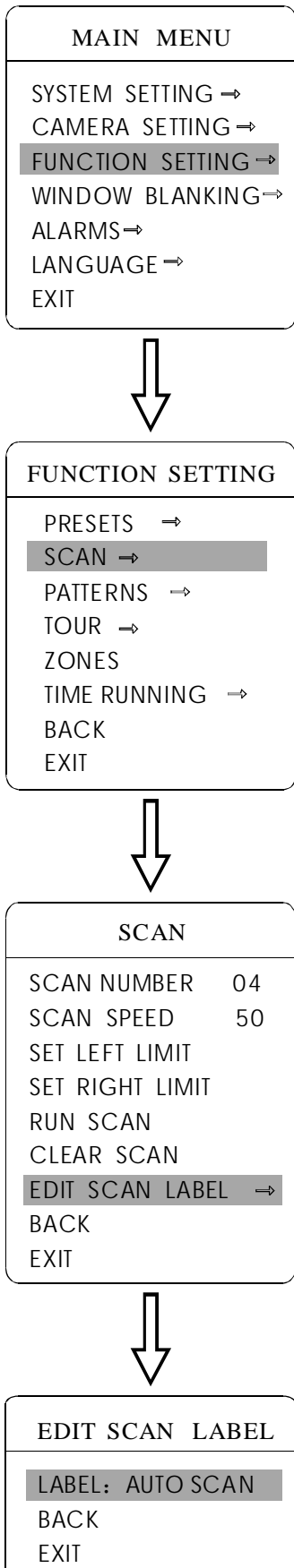

## 6.2 Scan

Scan is that pre-setting the right and left limit of dome, then the camera repeatedly scan between the two points at a stable speed, the same magnification and pan. Each dome has four scan.

1. The system enters into the main menu by calling 95 preset or by calling 9 preset twice within 3 seconds. click menu to enter “scan” menu, as the left picture shows.

- **【SCAN NUMBER】**
- **【SCAN SPEED】**
- **【SET LEFT LIMIT】**
- **【SET RIGHT LIMIT】**
- **【RUN SCAN】**
- **【CLEAR SCAN】**
- **【EDIT SCAN LABEL】**

2. Define current scan number: operate joystick ,move the cursor to **【SCAN NUMBER】** ,press **【OPEN】** ,tilt up/downjoystick to choose scan number, press **【OPEN】** to save .the following operations aim at the current scan number.

3. Scan speed setting: operate joystick to **【SCAN SPEED】** , press **【OPEN】** , tilt up/down joystick to adjust scan speed, press **【OPEN】** to save.

4. Left limit setting: operate joystick to **【SET LEFT LIMIT】** ,press **【OPEN】** , operate joystick to choose objective image, press **【OPEN】** to save. Right limit setting is the same as left limit setting.

5. Edit scan label: operate joystick, move the cursor to **【EDIT SCAN LABEL】** , press **【OPEN】** to enter submenu “edit label” , move the cursor to **【LABEL】** , the system will auto-set the label as AUTOSCAN, press **【OPEN】** to revise.



**NOTICE**

The label can set up to 16 characters, and doesn't need editing characters. Pressing **【OPEN】** continuously to jump over and using spacebar to replace the deleted characters. When you finish to edit a character, pressing **【OPEN】** to enter into the next editing character when you finish to edit the last character, pressing **【OPEN】** to save.

Press **【CLOSE】** to exit.

Character of label is suitable for choosing as follow: 0-9、A-Z、: <>-., Space. The editing ways of other labels are the same as above.

6. Run scan: operate joystick to **【RUN SCAN】** , press **【OPEN】** to exit the menu, and it starts to run scan.



**NOTICE**

1. Left limit and right limit of scan can't be set the same point.
2. Under scan process, speed, magnification and tilt direction won't change, if the speed, magnification and tilt direction of the two limits are inconsistent, run scan is base on left limit.

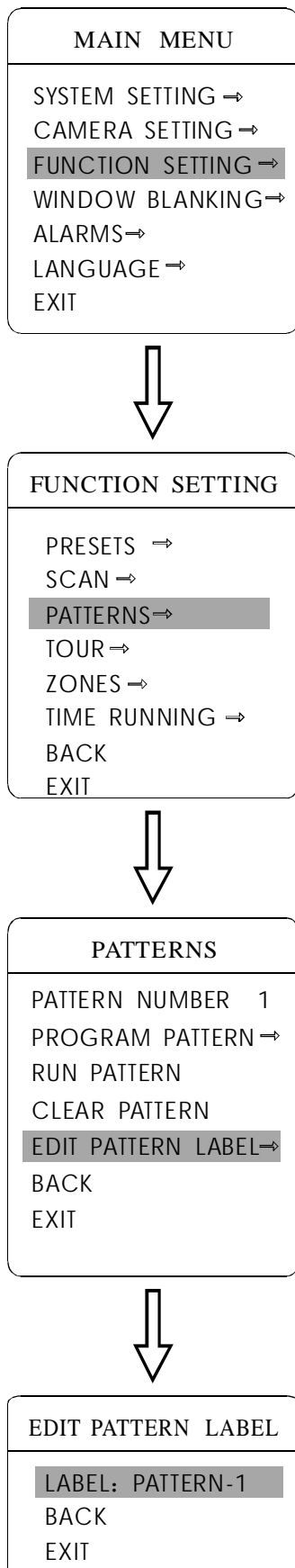

## 6.3 Pattern

Pattern is built-in function in camera; the PTZ can record tracks that are no less than 180s. (A series of pan/tilt controlling and lens controlling command). Each PTZ may set up to 4 pattern tours.

1. The system enters into the main menu by calling 95 preset or by calling 9 preset twice within 3 seconds.
2. Operate joystick and move the cursor to **【FUNCTION SETTING】**, press **【OPEN】** to enter submenu.
3. Operate joystick to **【PATTERN】**, press **【OPEN】** to enter menu “Pattern” .
  - **【PATTERN NUMBER】**
  - **【PROGRAM PATTERN】**
  - **【RUN PATTERN】**
  - **【CLEAR PATTERN】**
  - **【EDIT PATTERN LABEL】**
4. Choose pattern number: move the cursor to **【PATTERN NUMBER】**, press **【OPEN】**, pattern you choose as current pattern, the following operations aim at the current pattern;
5. Define current pattern tour: move the cursor to **【PROGRAM PATTERN】**, press **【OPEN】** to set pattern track, move the image random, and draw the focus. The PTZ has a tour that is no less than 180s, a series of park time, magnification, focus will be recorded, press **【OPEN】** to save.
6. Run pattern: operate joystick to **【RUN PATTERN】**, press **【OPEN】** to run, the PTZ will continuously and repeatedly record the specific track.



When carry out program, run, clear pattern and edit label, should choose pattern number at first.



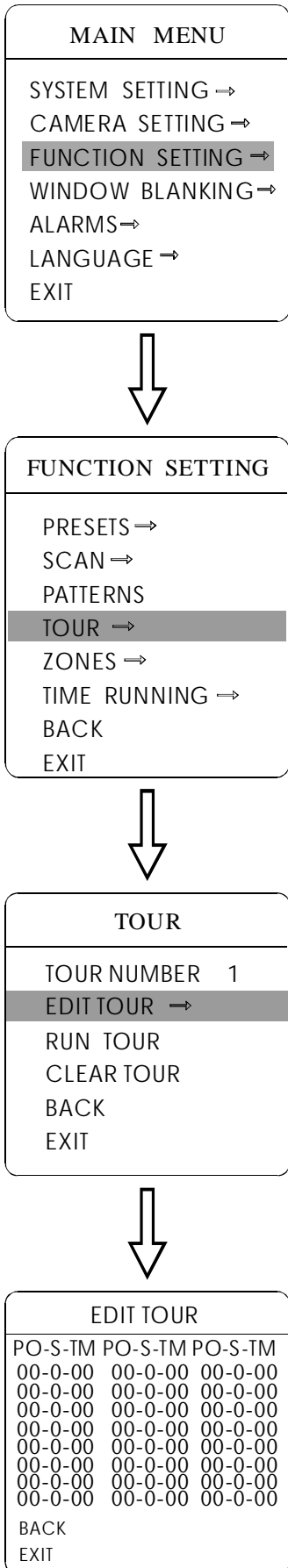

## 6.4 Tour

Tour is the built-in function in the PTZ, it will arrange the presets into the queue of auto-tour, and can set how long it will park at preset. Operate auto-tour is a process of incessantly transfer each preset. One tour can store 32 presets at most.

1. The system enters into the main menu by calling 95 preset or by calling 9 preset twice within 3 seconds.
2. Operate joystick and move the cursor to **【FUNCTION SETTING】**, press **【OPEN】** enter submenu.
3. Operate joystick and move the cursor to **【TOUR】**, press **【OPEN】** to enter menu “tour” ;
4. Set the park time of preset: Operate joystick, move the cursor to **【TOUR DWELL】**, press **【OPEN】**, there will be a sign ⚙ in the front of **【TOUR DWELL】**, the cursor jumps to right, tilt up/down to set park time, and the range is 000-255(s)
5. Set tour :move the cursor to **【EDIT TOUR】**, press **【OPEN】** to set tour interface, **【PO-S-TM】** set preset ,speed and time , press **【OPEN】**, the first dwell is activated , tilt up/down joystick to choose preset number, the preset numerical value should be within 1-80 preset , a tour can set up to 24 presets . Press **【OPEN】**, the cursor jump to the next dwell , operate joystick up/down to choose current arrival preset speed , total 8 level of speed ,increasingly from level 1 to level 8;Press **【OPEN】**, the cursor jumps to the next dwell , operate joystick up/down to set current preset maintaining time,60 seconds maximum . If set the presets of the second line , move the cursor to the second line , press **【OPEN】** to continue edit . Press **【OPEN】** to save after setting ,press **【CLOSE】** to exit.
6. Run tour: Operate joystick, move the cursor to **【RUN TOUR】**, press **【OPEN】** to exit the menu, it starts to run tour.



**NOTICE** the system will leap over the preset automatically when the stay time of one item setting up on 0; The PTZ will not run the tour of latter preset when preset or movement speed setting up on 0 .

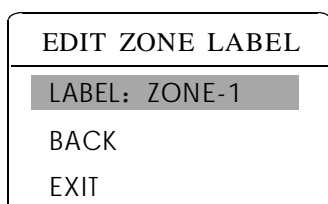
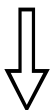
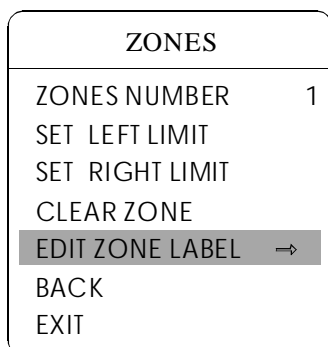
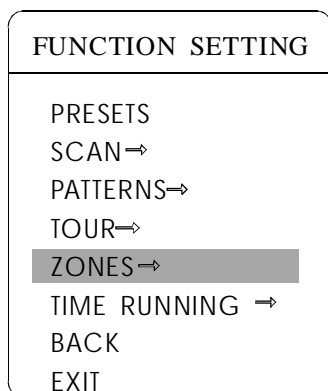
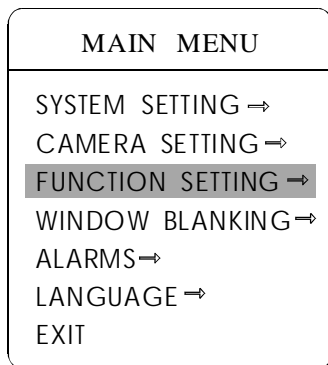

### 6.5 Zone

Each PTZ may be set up to 8 zones; the regional scene can't be overlapped. User can set label for each zone. When setting **【ZONE LABEL】** as ON, the PTZ will display zone label as it runs some zone. It is convenient to know the zone that the camera shoots by setting zone label.

1. The system enters into the main menu by calling 95 preset or by calling 9 preset twice within 3 seconds.
2. Operate the joystick and move the cursor to **【FUNCTION SETTING】**, press **【OPEN】** to enter submenu.
3. Operate the joystick and move the cursor to **【ZONES】**, press **【OPEN】** to enter submenu, as the left picture shows.
  - **【ZONES NUMBER】**
  - **【SET LEFT LIMIT】**
  - **【SET RIGHT LIMIT】**
  - **【CLEAR ZONE】**
  - **【EDIT ZONE LABEL】**

Regard the left/right limit as the demarcation line, and set the middle part as a zone. Various operational ways are the same as other settings in the menu. Therefore we won't explain it again.

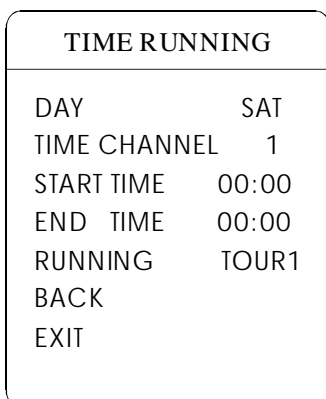
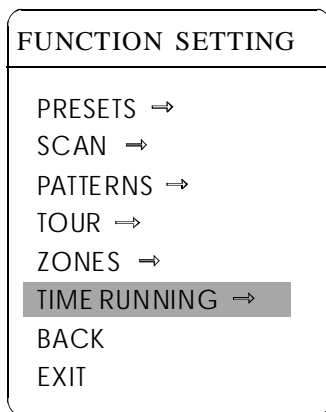
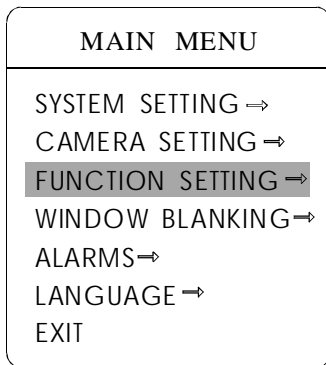

## 6.6 Time Running

User can set the time of preset, scan, tour and pattern.

1. Call 95 preset or call 9 preset twice within 3 seconds to enter into the main menu.
2. Operate the joystick and move the cursor to **【FUNCTION SETTING】** , press **【OPEN】** to call the submenu.
3. Operate the joystick and move the cursor to **【TIME RUNNING】** , press **【OPEN】** to enter into the menu setting. Please refer to the left picture.
  - 【DAY】** set the date
  - 【TIME CHANNEL】** 4 channels can be set.
  - 【START TIME】** Set the start time
  - 【END TIME】** Set the end time
  - 【RUNNING】** User can set the preset , scan , tour , pattern to every channel.(1-4)
4. This channel will not conflict with other channels when you set **【RUNNING】** as OFF.

1. When user do the actions of scan, tour or pattern, if the time is over, the current action will be stopped, the dome will execute park action. After the time, the dome will resume the preset and state which is set before the park time. (Before the park time, if the PTZ is on some preset, the PTZ will resume the preset, if PTZ execute the action of scanning, tour or pattern, the PTZ will resume original action. If users handle some action with keyboard, PTZ will also resume the action which users are going on with keyboard.)

2. During the period of time running, it doesn't allowed to call park action. User operate the dome, time running function will be interrupted, if there is no action during 10s, the time is still in the period of time running, and return to time running function. Or if there is a park action, it will be done the park action.

3. Time running function can't be implemented as user set preset, pattern, right and left limit of scan and other functions.

4. When the PTZ execute alarm, timing, idle function, the priority for alarm is the highest, for timing is the second, for idle is the last.



**NOTICE**

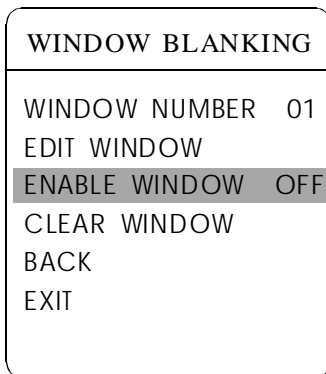
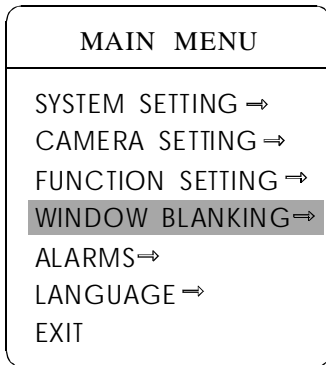

## 7. Privacy zone masking

Privacy function can show someone piece of regional shielding while protecting. For example, protect the window of bedroom or ATM of bank. A PTZ can set up to 24 privacy windows. (Masking setting function is relative with the model of camera module. The masking numbers will be different according to the different cameras.)

1. The system enters into the main menu by calling 95 preset or by calling 9 preset twice within 3 seconds.

2. Operate the joystick to **【WINDOW BLANKING】**, press **【OPEN】** to enter menu “window blanking”.

- **【WINDOW NUMBER】** choose window number as current privacy window, other choices in the menu just aim at current privacy window;
- **【EDIT WINDOW】** program current window;
- **【ENABLE WINDOW】** permit/prohibit current privacy window, there are two choices: ON---permit current privacy window/OFF---prohibit current privacy window
- **【CLEAR WINDOW】** clear current privacy window, after clearing it, the window will auto- change as OFF.

3. Program current privacy window: Firstly choose window number, then do the following operations:

- a. Operate the joystick, move the cursor to **【EDIT WINDOW】**, press **【OPEN】** to move the image that need privacy window to display in the screen.
- b. Press **【OPEN】**, there will be a square displaying in the center of the screen, operate the joystick, and move the square to the central place that need to conceal.
- c. Press **【OPEN】**, operate the joystick to adjust the size of privacy zone: joystick to up, the height is increased; joystick to down, the height is reduced; joystick to right, the width is increased; joystick to left, the width is reduced.
- d. Press **【OPEN】** to save the current privacy zone setting, and the window will auto-change as ON at the same time.

Privacy zone masking



This function is decided by the parameter of built-in camera, if the camera has not this function, this option is invalid. (N/A)

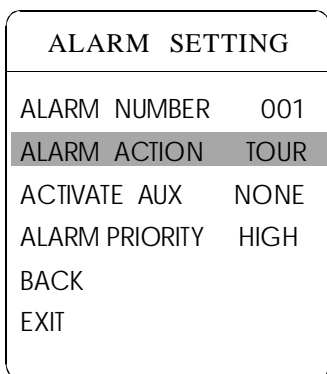
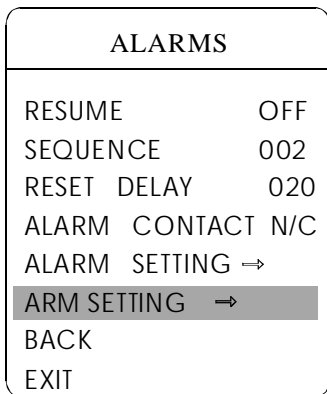
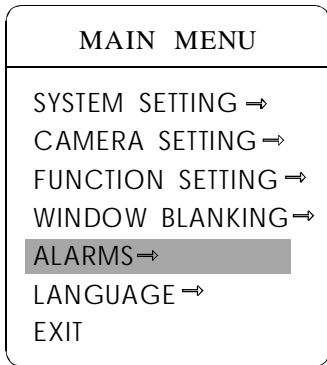

## 8. Alarm function

The PTZ may connect with 7 alarm input, 2 alarm output, and support alarm linkage. The external alarm message sends to the PTZ, then the PTZ moves to alarm point shoot (to call preset, auto scan, auto cruise and auto pattern), and choose that to run alarm output or not.

1. The system enters into the main menu by calling 95 preset or by calling 9 preset twice within 3 seconds. click each menu according to the left picture, then enter menu alarm, choices as follow:

- **【RESUME】** resume mode after relieving alarm input, there are two choices: ON---clear alarm output, the PTZ will stop.  
OFF---non-clear alarm output.
- **【SEQUENCE】** The park time between two alarm in the same priority, the range is 1-60s.
- **【RESET DELAY】** set alarm reset and delay the time (1-225s), how long to relieve and run **【RESUME】** after the PTZ receives alarm message.
- **【ALARM CONTACT】** set state of the relay. N/C---often close the state, N/O---often hold the state. If setting as often closing the state, the relay is in closing the state when there is no alarm to output; when there is alarm to output, the relay is in holding the state.
- **【ALARM SETTING】**
- **【ARM SETTING】**

2. Operate joystick and move the cursor to **【ALARM SETTING】**, press **【OPEN】** to enter the menu alarm setting

- **【ALARM NUMBER】** alarm number is corresponding with 12 bits plug in the external switching board of the PTZ (as below shows). 001 priority is the highest, 007 priority is the lowest. The two lines alarm input at the same time, the PTZ run alarm that the highest priority.
- **【ALARM ACTION】** as current alarm input, to run the action. Choices for choosing as follow. NONE---none action/SCAN/PAT X---run a pattern tour /TOUR---run tour/PRESET---call preset, when the PTZ number is set as 1, to call preset 1; when the PTZ number is set as 2, to call preset2.
- **【ACTIVATE AUX】** as current alarm input, to run alarm output or not. NONE---none alarm output/AUX 1---the first alarm output/AUX 2---the secondary alarm output/BOTH--- two alarms output.
- **【ALARM PRIORITY】** alarm priority can be defined as three grades: high, middle, low.

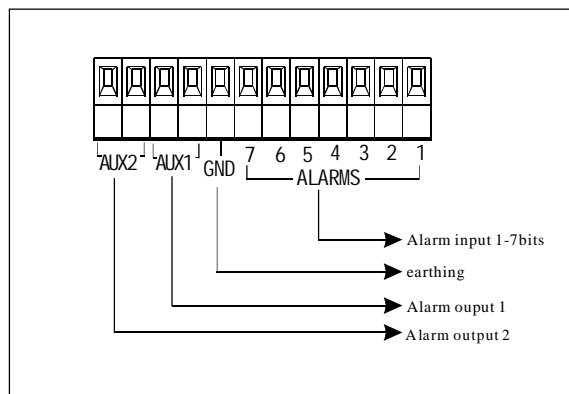

MAIN MENU	
SYSTEM SETTING →	
CAMERA SETTING →	
FUNCTION SETTING →	
WINDOW BLANKING →	
<b>ALARMS →</b>	
LANGUAGE →	
EXIT	

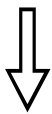

ALARMS	
RESUME	OFF
SEQUENCE	002
RESET DELAY	020
ALARM CONTACT	N/C
ALARM SETTING →	
<b>ARM SETTING →</b>	
BACK	
EXIT	



ARM SETTING	
DAY	SUN
<b>ARM STATE</b>	<b>OFF</b>
ARM TIME	N/A
UNARM TIME	N/A
BACK	
EXIT	

## 8.1 ARM Setting

1. Call 95 preset or call 9 preset twice within 3 seconds and then input the password to enter the main menu.
2. Operate the joystick and move the cursor to **【ALARMS】**, press **【OPEN】** to call the submenu.
3. Operate the joystick and move the cursor to **【ARM SETTING】**, press **【OPEN】** to call the submenu. Please refer to the left picture.
4. Operate the joystick and move the cursor to **【DAY】**, Press **【OPEN】** to choose it, Operate the joystick up and down to set date, set the date according to the week. To set the Alarm state and Alarm date based on the time.

- **【ARM STATE】** Alarm off /Alarm on  
(Alarm Setting is noneffective under Alarm OFF. Alarm Setting is effective under Alarm ON)
- **【ARM TIME】** : User can set the alarm time.
- **【UNARM TIME】** : User can set the alarm off time.
- **【BACK】** : back to the former menu.
- **【EXIT】** : Exit the menu.

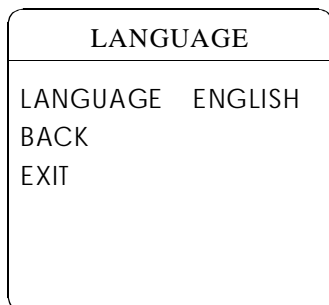
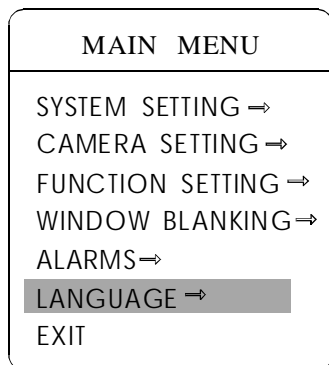

## 9. Set Language

1. Call 95 preset or call 9 preset twice within 3 seconds and then input the password to enter the main menu.
2. Operate the joystick , move the cursor to **【LANGUAGE】** , press **【OPEN】** to call the submenu.
3. Operate the joystick to choose the language, English and French can be choosed, then press **【OPEN】** to save.

# 10. Appendix

## 10.1 Menu Index

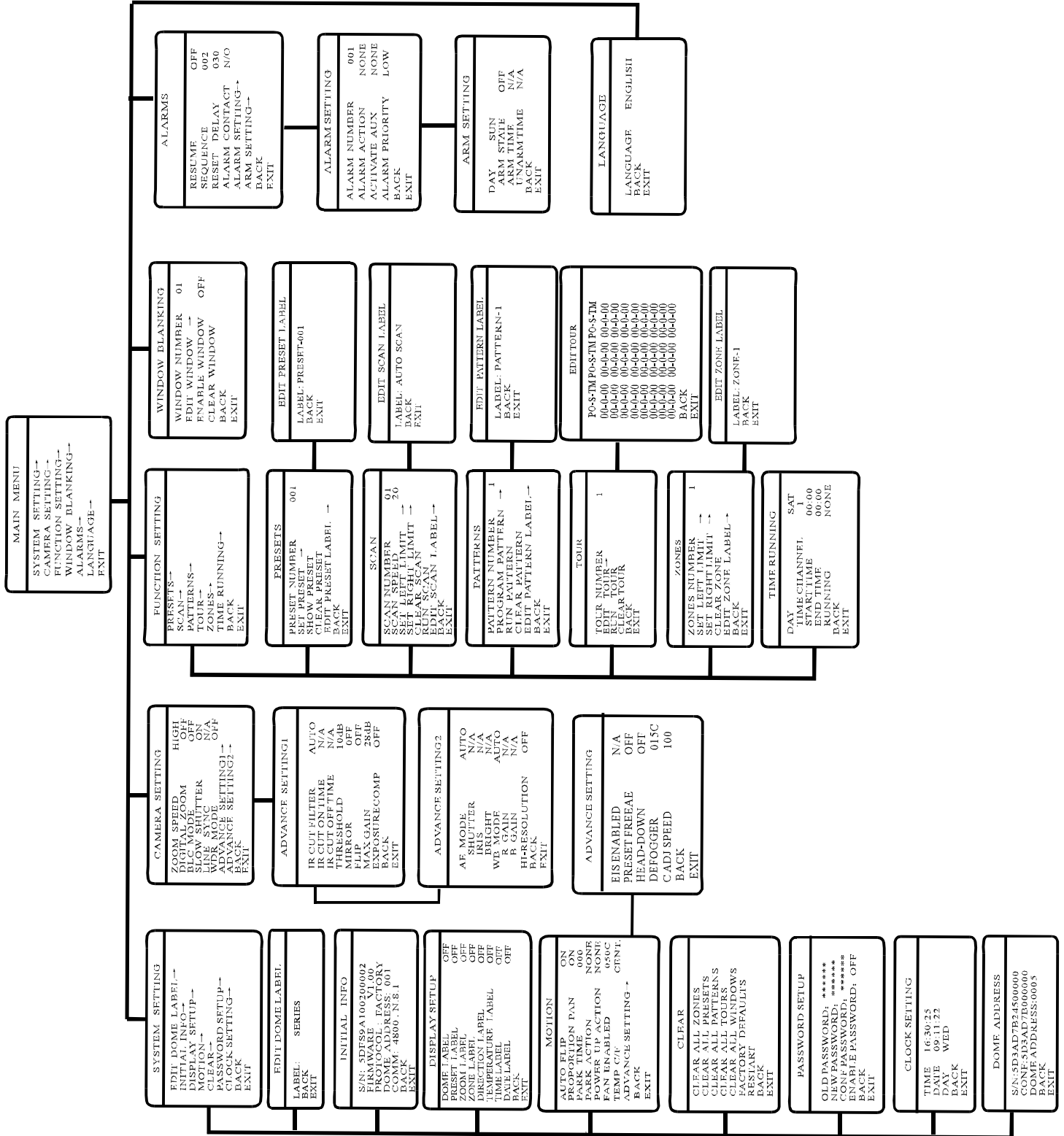



## 10.2 RS485 Bus Basic Knowledge

### Ø Characteristics of RS485 Bus

As specified by RS485 standard, Rs485 Bus is of half-duplexed data transmission cables with characteristic impedance as 120Ω. The maximum load capacity is 32 unit loads (including main controller and controlled equipment.)

### Ø Transmission distances of RS485 Bus

When user selects the 0.56mm(24AWG)twisted pair wires as data transmission cable, the maximum theoretical transmitting distance are as follows:

Baud rate	Max distance
2400BPS	1800m
4800BPS	1200m
9600BPS	800m
19200BPS	600m

If user selects thinner cables, or installs the PTZ in an environment with strong electromagnetic interference, or connects lots of equipment to the RS485 Bus, the maximum transmitting distance will be decreased. To increase the maximum transmitting distance, do the contrary.

### Ø Connection and termination resistor

The Rs485 standards require a daisy-chain Connection between the equipment. There must be termination resistors with 120Ω (as the picture 10.2-1). Please refer to picture 10.2-2 for simple connection. “D” should not exceed 7m.

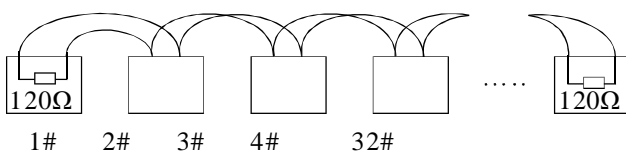

Picture 10.2-1

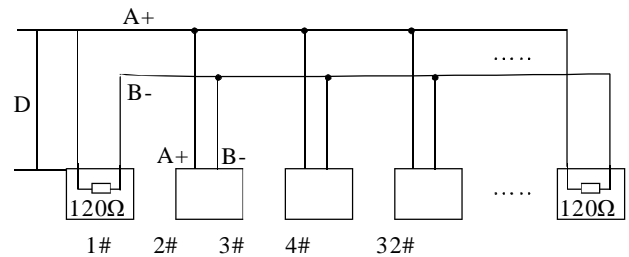

Picture 10.2-2

**Ø Problems in practical connections**

In some circumstances user adopts a star configuration in practical connection. The termination resistors must be connected to the two equipment 1# and 5# in Picture 10.2-3. As the star configuration is not in conformity with the requirements of RS485 standards, problems such as signal reflections, lower anti-interference performance arise when the cables are long in the connection. The reliability of control signals is decreased with the phenomena that the PTZ does not respond to or just responds at intervals to the controller, or does continuous operation without stop.

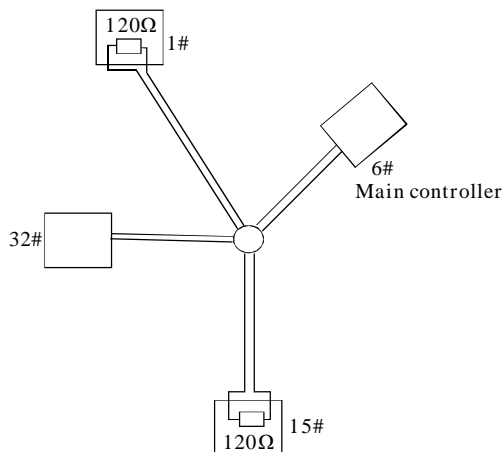

Picture 10.2-3

In such circumstances the factory recommends the usage of RS485 distributor. The distributor can change the star configuration connection to the mode of connection stipulated in the RS485 standards. The new connection achieves reliable data transmission. (Refer to Picture 10.2-4).

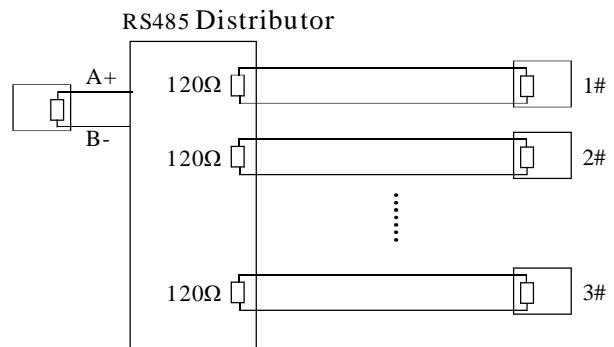

Picture 10.2-4

**Ø RS485 Bus troubleshooting**

Trouble	Possible cause	Solution
PTZ can do self-test but cannot be controlled	<ol style="list-style-type: none"> <li>1. The address and baud rate setting of PTZ are not in conformity with those of controller.</li> <li>2. The "+" and "-" connection of Rs485 Bus is incorrect.</li> <li>3. The PTZ is very far away from controller.</li> <li>4. There are too many PTZs connected in the System.</li> </ol>	<ol style="list-style-type: none"> <li>1. Change the address and baud rate of controller or PTZ</li> <li>2. Replace RS485 Bus wires</li> <li>3. Make sure the connections are fully seated</li> </ol>
The PTZ can be controlled but the operation is not smooth.	<ol style="list-style-type: none"> <li>1. The RS485 Bus line is not in good contact with the connectors.</li> <li>2. One wire of the RS485 Bus is broken.</li> <li>3. The PTZ is very far from controller.</li> <li>4. There are too many PTZ connected in the system.</li> </ol>	<ol style="list-style-type: none"> <li>1. Secure the connection ;</li> <li>2. Replace RS485 Bus Wires</li> <li>3. Add termination resistors to the system</li> <li>4. Install RS485 distributor</li> </ol>

## 10.3 DIP switch setup

Open base, there are two code switches with 8 digits, SW1 and SW2. SW1 is for setting of PTZ ID. SW2 is for settings of control protocol, baud rate, terminal resistance connect.

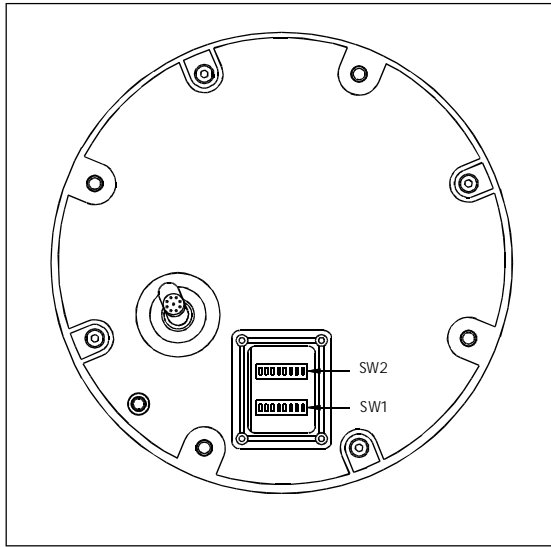

Picture 10.3-1

In the following list, "1" set DIP as "ON", 0 set DIP as "OFF"

### 10.3.1 Baud rate setup (SW2) :

Please according to "AppdienxRS485 Bus Basic knowledge", to check whether Baud rate is satisfied with the demand of transmission distance.

Baud rate	Switch number(Sw2)
	(Bit) 6 7
2400bps	0 0
4800bps	1 0
9600bps	0 1
19200bps	1 1

### 10.3.2 Protocol setup (SW2)

PROTOCOL	SWITCH NUMBER (SW2)				
	(Bit) 1	2	3	4	5
FACTORY (FACTORY PROTOCOL)	0	0	0	0	0
PELCO	1	0	0	0	0
SAE	0	1	0	0	0
VCL	1	1	0	0	0
VICON	1	0	1	0	0
PANASONIC	1	1	1	0	0
SAMSUNG	0	0	0	1	0
DIAMOND	1	0	0	1	0
KALATEL	0	1	0	1	0
LILIN	1	1	0	1	0
VIDOB02	0	0	1	1	0
LILIN	1	1	0	1	0
PHILIPS	0	0	0	1	1
AD	1	0	0	1	1
RESERVED	OTHERS				

### 10.3.3 ID setting (SW1)

The ID switch in decoder and the ID setting of the PTZ as follow, in the picture, "1" set DIP switch as "NO", "0" set DIP switch as OFF.

ID	Switch number (Sw1)								ID	Switch number (Sw1)								
	(Bit)	1	2	3	4	5	6	7		8	(Bit)	1	2	3	4	5	6	7
Factory defaults set as debug address	0	0	0	0	0	0	0	0	34	0	1	0	0	0	0	1	0	0
1	1	0	0	0	0	0	0	0	35	1	1	0	0	0	0	1	0	0
2	0	1	0	0	0	0	0	0	36	0	0	1	0	0	0	1	0	0
3	1	1	0	0	0	0	0	0	37	1	0	1	0	0	0	1	0	0
4	0	0	1	0	0	0	0	0	38	0	1	1	0	0	0	1	0	0
5	1	0	1	0	0	0	0	0	39	1	1	1	0	0	0	1	0	0
6	0	1	1	0	0	0	0	0	40	0	0	0	1	0	1	0	0	0
7	1	1	1	0	0	0	0	0	41	1	0	0	1	0	1	0	0	0
8	0	0	0	1	0	0	0	0	42	0	1	0	1	0	1	0	0	0
9	1	0	0	1	0	0	0	0	43	1	1	0	1	0	1	0	0	0
10	0	1	0	1	0	0	0	0	44	0	0	1	1	0	1	0	0	0
11	1	1	0	1	0	0	0	0	45	1	0	1	1	0	1	0	0	0
12	0	0	1	1	0	0	0	0	46	0	1	1	1	0	1	0	0	0
13	1	0	1	1	0	0	0	0	47	1	1	1	1	0	1	0	0	0
14	0	1	1	1	0	0	0	0	48	0	0	0	0	1	1	0	0	0
15	1	1	1	1	0	0	0	0	49	1	0	0	0	1	1	0	0	0
16	0	0	0	0	1	0	0	0	50	0	1	0	0	1	1	0	0	0
17	1	0	0	0	1	0	0	0	51	1	1	0	0	1	1	0	0	0
18	0	1	0	0	1	0	0	0	52	0	0	1	0	1	1	0	0	0
19	1	1	0	0	1	0	0	0	53	1	0	1	0	1	1	0	0	0
20	0	0	1	0	1	0	0	0	54	0	1	1	0	1	1	0	0	0
21	1	0	1	0	1	0	0	0	55	1	1	1	0	1	1	0	0	0
22	0	1	1	0	1	0	0	0	56	0	0	0	1	1	1	0	0	0
23	1	1	1	0	1	0	0	0	57	1	0	0	1	1	1	0	0	0
24	0	0	0	1	1	0	0	0	58	0	1	0	1	1	1	0	0	0
25	1	0	0	1	1	0	0	0	59	1	1	0	1	1	1	0	0	0
26	0	1	0	1	1	0	0	0	60	0	0	1	1	1	1	0	0	0
27	1	1	0	1	1	0	0	0	61	1	0	1	1	1	1	0	0	0
28	0	0	1	1	1	0	0	0	62	0	1	1	1	1	1	0	0	0
29	1	0	1	1	1	0	0	0	63	1	1	1	1	1	1	0	0	0
30	0	1	1	1	1	0	0	0	64	0	0	0	0	0	0	1	0	0
31	1	1	1	1	1	0	0	0	65	1	0	0	0	0	0	1	0	0
32	0	0	0	0	0	1	0	0	66	0	1	0	0	0	0	1	0	0
33	1	0	0	0	0	1	0	0	67	1	1	0	0	0	0	1	0	0

# Appendix

ID	Switch number (Sw1)							
	(Bit)1	2	3	4	5	6	7	8
68	0	0	1	0	0	0	1	0
69	1	0	1	0	0	0	1	0
70	0	1	1	0	0	0	1	0
71	1	1	1	0	0	0	1	0
72	0	0	0	1	0	0	1	0
73	1	0	0	1	0	0	1	0
74	0	1	0	1	0	0	1	0
75	1	1	0	1	0	0	1	0
76	0	0	1	1	0	0	1	0
77	1	0	1	1	0	0	1	0
78	0	1	1	1	0	0	1	0
79	1	1	1	1	0	0	1	0
80	0	0	0	0	1	0	1	0
81	1	0	0	0	1	0	1	0
82	0	1	0	0	1	0	1	0
83	1	1	0	0	1	0	1	0
84	0	0	1	0	1	0	1	0
85	1	0	1	0	1	0	1	0
86	0	1	1	0	1	0	1	0
87	1	1	1	0	1	0	1	0
88	0	0	0	1	1	0	1	0
89	1	0	0	1	1	0	1	0
90	0	1	0	1	1	0	1	0
91	1	1	0	1	1	0	1	0
92	0	0	1	1	1	0	1	0
93	1	0	1	1	1	0	1	0
94	0	1	1	1	1	0	1	0
95	1	1	1	1	1	0	1	0
96	0	0	0	0	0	1	1	0
97	1	0	0	0	0	1	1	0
98	0	1	0	0	0	1	1	0
99	1	1	0	0	0	1	1	0
100	0	0	1	0	0	1	1	0
101	1	0	1	0	0	1	1	0
ID	Switch number (Sw1)							
	(Bit)1	2	3	4	5	6	7	8
102	0	1	1	0	0	1	1	0
103	1	1	1	0	0	1	1	0
104	0	0	0	1	0	1	1	0
105	1	0	0	1	0	1	1	0
106	0	1	0	1	0	1	1	0
107	1	1	0	1	0	1	1	0
108	0	0	1	1	0	1	1	0
109	1	0	1	1	0	1	1	0
110	0	1	1	1	0	1	1	0
111	1	1	1	1	0	1	1	0
112	0	0	0	0	1	1	1	0
113	1	0	0	0	1	1	1	0
114	0	1	0	0	1	1	1	0
115	1	1	0	0	1	1	1	0
116	0	0	1	0	1	1	1	0
117	1	0	1	0	1	1	1	0
118	0	1	1	0	1	1	1	0
119	1	1	1	0	1	1	1	0
120	0	0	0	1	1	1	1	0
121	1	0	0	1	1	1	1	0
122	0	1	0	1	1	1	1	0
123	1	1	0	1	1	1	1	0
124	0	0	1	1	1	1	1	0
125	1	0	1	1	1	1	1	0
126	0	1	1	1	1	1	1	0
127	1	1	1	1	1	1	1	0
128	0	0	0	0	0	0	0	1
129	1	0	0	0	0	0	0	1
130	0	1	0	0	0	0	0	1
131	1	1	0	0	0	0	0	1
132	0	0	1	0	0	0	0	1
133	1	0	1	0	0	0	0	1
134	0	1	1	0	0	0	0	1
135	1	1	1	0	0	0	0	1

ID	Switch number (Swl)								ID	Switch number (Swl)							
	(Bit)	1	2	3	4	5	6	7		8	(Bit)	1	2	3	4	5	6
136	0	0	0	1	0	0	0	1	170	0	1	0	1	0	1	0	1
137	1	0	0	1	0	0	0	1	171	1	1	0	1	0	1	0	1
138	0	1	0	1	0	0	0	1	172	0	0	1	1	0	1	0	1
139	1	1	0	1	0	0	0	1	173	1	0	1	1	0	1	0	1
140	0	0	1	1	0	0	0	1	174	0	1	1	1	0	1	0	1
141	1	0	1	1	0	0	0	1	175	1	1	1	1	0	1	0	1
142	0	1	1	1	0	0	0	1	176	0	0	0	0	1	1	0	1
143	1	1	1	1	0	0	0	1	177	1	0	0	0	1	1	0	1
144	0	0	0	0	1	0	0	1	178	0	1	0	0	1	1	0	1
145	1	0	0	0	1	0	0	1	179	1	1	0	0	1	1	0	1
146	0	1	0	0	1	0	0	1	180	0	0	1	0	1	1	0	1
147	1	1	0	0	1	0	0	1	181	1	0	1	0	1	1	0	1
148	0	0	1	0	1	0	0	1	182	0	1	1	0	1	1	0	1
149	1	0	1	0	1	0	0	1	183	1	1	1	0	1	1	0	1
150	0	1	1	0	1	0	0	1	184	0	0	0	1	1	1	0	1
151	1	1	1	0	1	0	0	1	185	1	0	0	1	1	1	0	1
152	0	0	0	1	1	0	0	1	186	0	1	0	1	1	1	0	1
153	1	0	0	1	1	0	0	1	187	1	1	0	1	1	1	0	1
154	0	1	0	1	1	0	0	1	188	0	0	1	1	1	1	0	1
155	1	1	0	1	1	0	0	1	189	1	0	1	1	1	1	0	1
156	0	0	1	1	1	0	0	1	190	0	1	1	1	1	1	0	1
157	1	0	1	1	1	0	0	1	191	1	1	1	1	1	1	0	1
158	0	1	1	1	1	0	0	1	192	0	0	0	0	0	0	1	1
159	1	1	1	1	1	0	0	1	193	1	0	0	0	0	0	1	1
160	0	0	0	0	0	1	0	1	194	0	1	0	0	0	0	1	1
161	1	0	0	0	0	1	0	1	195	1	1	0	0	0	0	1	1
162	0	1	0	0	0	1	0	1	196	0	0	1	0	0	0	1	1
163	1	1	0	0	0	1	0	1	197	1	0	1	0	0	0	1	1
164	0	0	1	0	0	1	0	1	198	0	1	1	0	0	0	1	1
165	1	0	1	0	0	1	0	1	199	1	1	1	0	0	0	1	1
166	0	1	1	0	0	1	0	1	200	0	0	0	1	0	0	1	1
167	1	1	1	0	0	1	0	1	201	1	0	0	1	0	0	1	1
168	0	0	0	1	0	1	0	1	202	0	1	0	1	0	0	1	1
169	1	0	0	1	0	1	0	1	203	1	1	0	1	0	0	1	1

# Appendix

ID	Switch number (Sw1)							
	(Bit)1	2	3	4	5	6	7	8
204	0	0	1	1	0	0	1	1
205	1	0	1	1	0	0	1	1
206	0	1	1	1	0	0	1	1
207	1	1	1	1	0	0	1	1
208	0	0	0	0	1	0	1	1
209	1	0	0	0	1	0	1	1
210	0	1	0	0	1	0	1	1
211	1	1	0	0	1	0	1	1
212	0	0	1	0	1	0	1	1
213	1	0	1	0	1	0	1	1
214	0	1	1	0	1	0	1	1
215	1	1	1	0	1	0	1	1
216	0	0	0	1	1	0	1	1
217	1	0	0	1	1	0	1	1
218	0	1	0	1	1	0	1	1
219	1	1	0	1	1	0	1	1
220	0	0	1	1	1	0	1	1
221	1	0	1	1	1	0	1	1
222	0	1	1	1	1	0	1	1
223	1	1	1	1	1	0	1	1
224	0	0	0	0	0	1	1	1
225	1	0	0	0	0	1	1	1
226	0	1	0	0	0	1	1	1
227	1	1	0	0	0	1	1	1
228	0	0	1	0	0	1	1	1
229	1	0	1	0	0	1	1	1
230	0	1	1	0	0	1	1	1
231	1	1	1	0	0	1	1	1
232	0	0	0	1	0	1	1	1
233	1	0	0	1	0	1	1	1
234	0	1	0	1	0	1	1	1
235	1	1	0	1	0	1	1	1
236	0	0	1	1	0	1	1	1
237	1	0	1	1	0	1	1	1
ID	Switch number (Sw1)							
	(Bit)1	2	3	4	5	6	7	8
238	0	1	1	1	0	1	1	1
239	1	1	1	1	0	1	1	1
240	0	0	0	0	1	1	1	1
241	1	0	0	0	1	1	1	1
242	0	1	0	0	1	1	1	1
243	1	1	0	0	1	1	1	1
244	0	0	1	0	1	1	1	1
245	1	0	1	0	1	1	1	1
246	0	1	1	0	1	1	1	1
247	1	1	1	0	1	1	1	1
248	0	0	0	1	1	1	1	1
249	1	0	0	1	1	1	1	1
250	0	1	0	1	1	1	1	1
251	1	1	0	1	1	1	1	1
252	0	0	1	1	1	1	1	1
253	1	0	1	1	1	1	1	1
254	0	1	1	1	1	1	1	1
255	1	1	1	1	1	1	1	1



**Notice:** Debug address: (Only factory protocol and Pelco can be set): if the camera address is set as 0, user can select any protocols to control the PTZ.

## 11. Installation

### 11.1 Caution

- | Please refer to user manual before installation.
- | Power: DC12V, for actual needs, please refer to label of product.
- | Inside the dome is precision optical and electronic parts, please avoid severe press, hard vibration and other improper operation methods which may cause damage to product in transportation and installation.
- | Please do not disassemble parts inside of product at random, which may cause negative influence on use of product. No additional parts available.
- | Please comply with standards of Electrify Safety and use our own power transformer of product. Enough distance must be ensured between RS-485 cable, Video signal cable and equipments of high voltage when transmission. Thunder-proof, surge-proof and wave-proof, etc protection measures are needed.
- | Do not use product beyond the rated temperature, humidity or specifications of power. Do not place camera point to Sun or shining objects.
- | Do not use strong or abrasive cleansers to clean product, please use dry cloth to clean up dirt; Neutral cleanser is needed for dirt which is hard to eliminate.
- | Handle product with care so as to avoid crash or vibration. Damaged will be caused by incorrect usage.
- | Please fix product to the position which is solid and firm.
- | Please use special paper of lens to clean up dirt on Lens.

### 11.2 Lightning Proof and Surge Proof

This product uses TVS lightning Proof technology, can prevent from the damage of the equipment caused by kinds of pulse signal such as instant lightning strike of power below 4000V, the surge and so on.

At the same time, you must adopt the essential protective measure according to the actual situation regarding outdoor installation under the guarantee electricity security.

### 11.3 Water Proof

Outdoor PTZ has well waterproof, moisture-proof, dust proof performance, has achieved the Ip66 international standard. The indoor PTZ doesn't allowed to install in outdoor environment which is full of moisture and possibly enter water. You should prevent the product and the internal components from damage that caused by the long time waterdrop or spatter.

### 11.4 The preparation of installation

#### Ø The request of the quality of installation person and maintainer:

- All installation and maintenance work related this product should complete by technical personnel who have qualification of installation and maintenance.
- Please refer to this handbook for detail.

#### Ø Basic requirements

- All electrical work must be observe local latest electricity laws, regulation on fireproof as well as the related laws and regulations:
- Checking everything is completed according to packing list. Make sure the application place and the way of installation for PTZ is coincide with the request. If not, please contact your supplier.
- Please use this product according to the working conditions request.
- Please handle with the pan/tilt module carefully, do not extrude various structure parts; The down cover belongs to the senior optics part, do not touch with hand; Please do not get through power except for the electrifying inspection in process of installation.

#### Ø Check the structure intensity for installation space and installation site.

- Make sure you have enough space to hold this product and it's parts of installation in the site.
- Make sure the bearing capacity of ceiling, wall, bracket that installs the PTZ support the gross weight of the PTZ and the structural parts of installation. It is necessary to have the safe coefficient of 8-10 times or above.



# Warnings

## Ø Stuff Preparation

Please select the type of cables based on transmitting distance:

- Minimum video coaxial cable requirements:
  - 1) 75  $\Omega$  impedance
  - 2) All copper conductor wire
  - 3) 95% copper net structure

Domestic Gauge	International Gauge	Maximum Distance(ft/m)
RG59/U	RG59/U	750ft (229m)
5C-2V	RG6/U	1,000ft (305m)
7C-2V	RG11/U	1,500ft (457m)

- RS485 Communication cables  
(Refer to manual appendix)
- DC12V Power supply cable  
(Refer to manual appendix)
- Prepare 4pcs M6\*25mm bolt, to lock the PTZ and top of vehicle

## 11.5 Structure Introduction

The pan/tilt camera has four parts: camera module shell, top shell, base board and DIP switch board. After setting DIP switches, pls make sure the sealed cushion had been installed properly and lock the board, or water filter inside of the PTZ.

## Ø Set switches

There is separated switches structure on the base board of vehicle PTZ. Pls check the "switches setting" in the manual appendix to set PTZ baud rate, protocol and ID address.

## Ø Keep All the Original Package Materials

Please preserve the mode original package material properly after opening the PTZ packing, in order to mail the PTZ that is wrapped with original package material to the agent or return it to the factory to repair if problem occur. It is likely to bring on the damage that caused by the transport accident on the way if the mode uses the nonoriginal package material, and extra cost may arise accordingly.

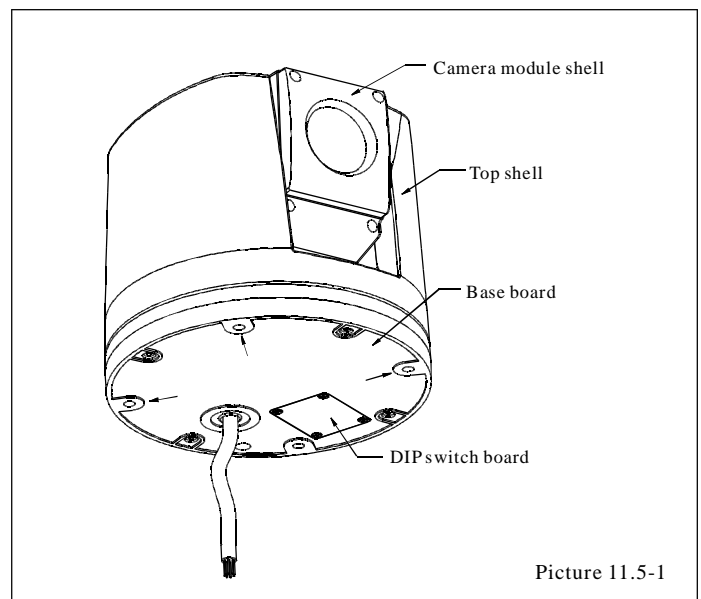

Picture 11.5-1

## 11.6 Basic Size graph

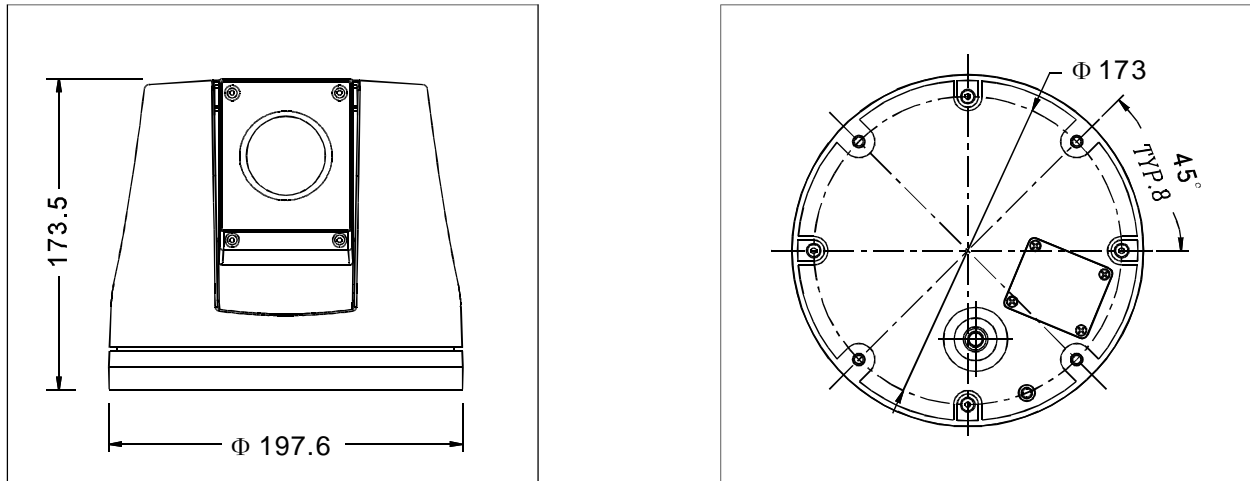

Picture 11.6-1

## 11.7 Installation

### 11.7.1 Drill installation hole

As picture 11.7.1-1, according to the size of the base board, drill holes on the top board of the vehicle. Pls pay attention to the direction.

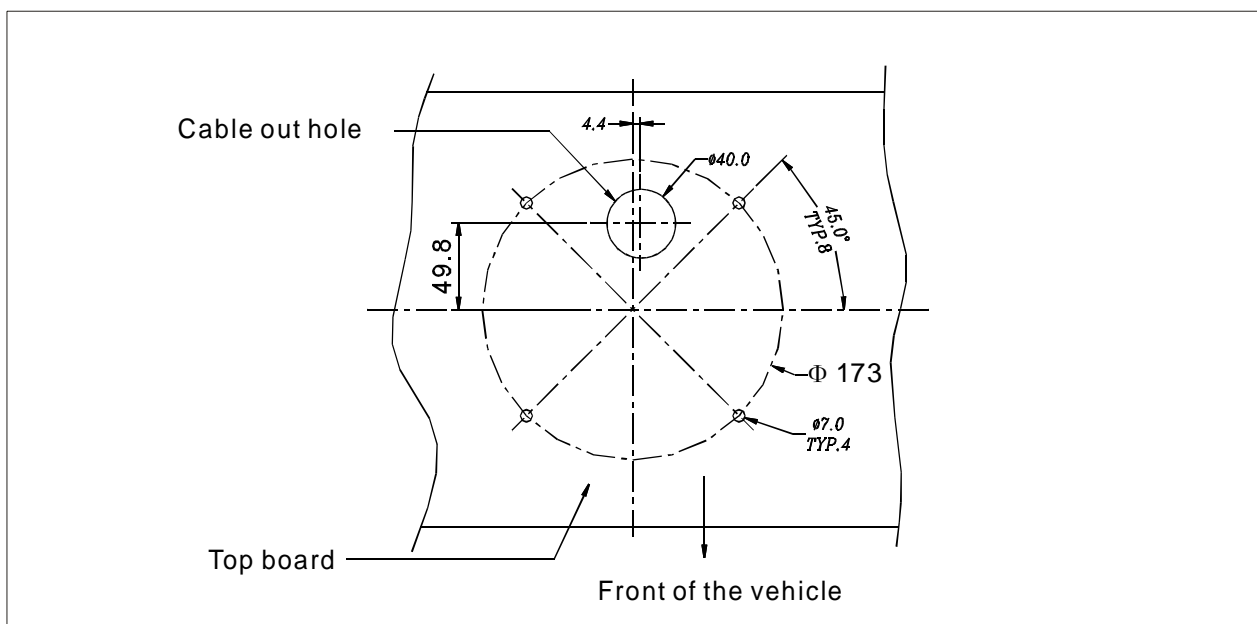

Picture 11.7.1-1

## 11.7.2 Installation between PTZ and top board

Before lock the bolt, pls make sure the PTZ baud rate, protocol and ID address had been set. As picture 11.7.2-1, use M6 bolt to lock PTZ onto the top board of vehicle.

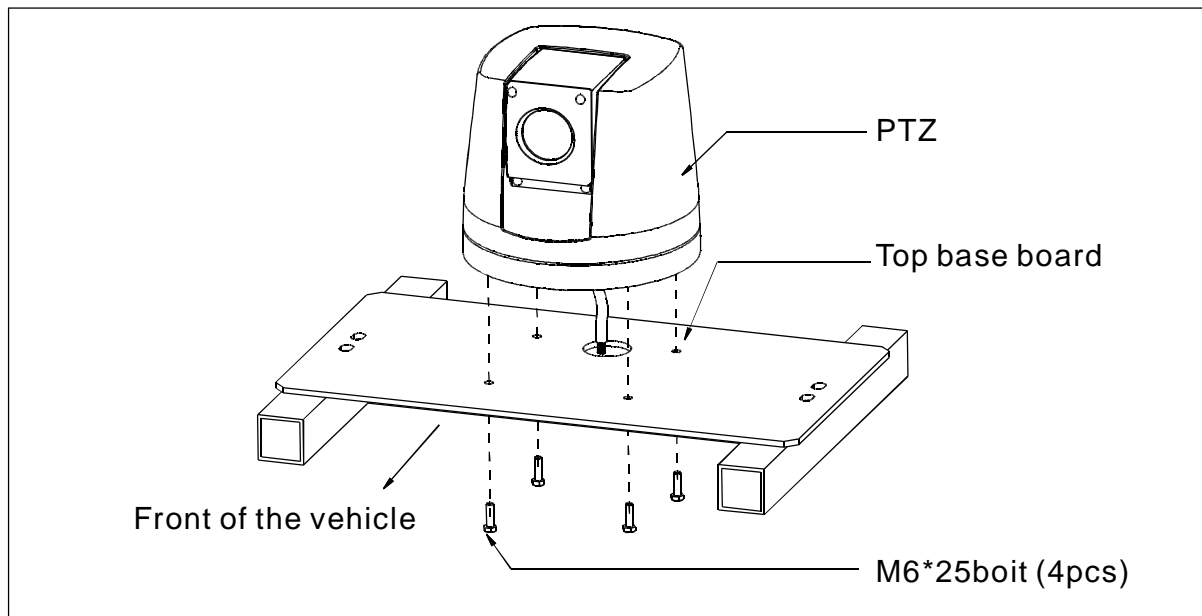

Picture 11.7.2-1

## 11.8 Switches setting

Pls check the "switch setting" in the manual appendix to set baud rate, protocol and ID address.

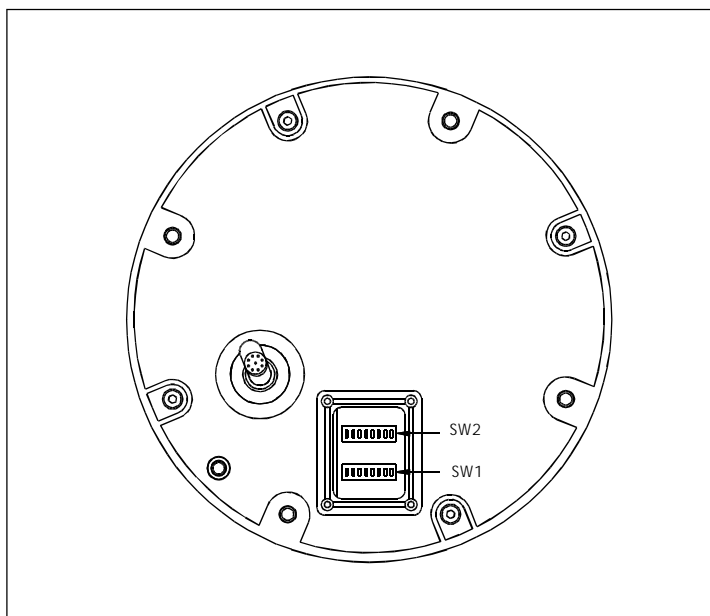

Picture 11.8-1

### 11.9 Cabling Connection

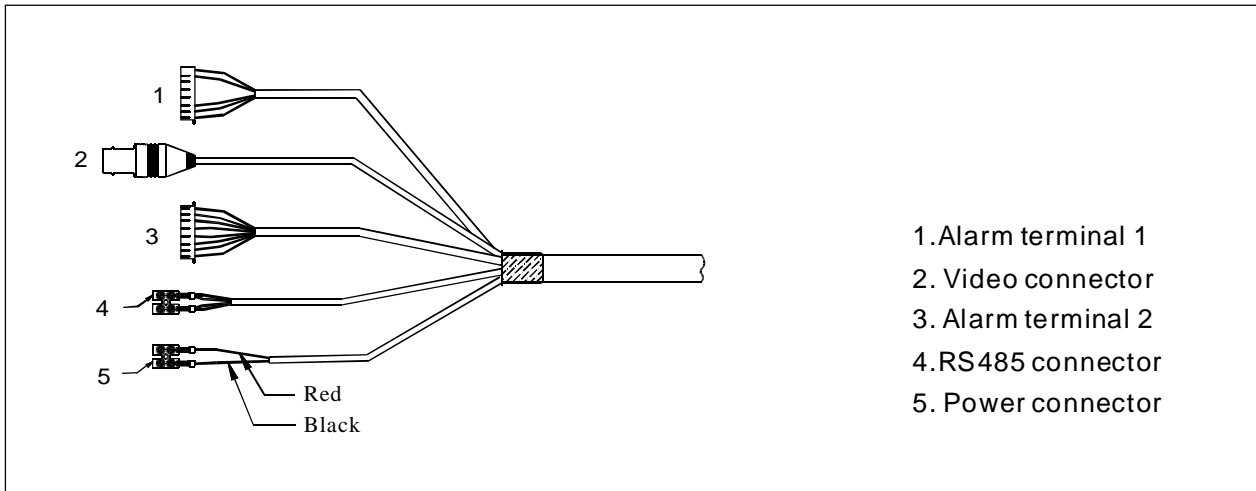

Picture 11.9

**Alarm terminal 1 :**

- RED: ALM1
- PINK: ALM2
- YELLOW: ALM3
- GREEN: ALM4
- BLACK: COM
- WHITE: NO
- BLUE: NC

**Alarm terminal 2 :**

- AQUA: NC2
- BROWN: NO2
- GRAY: ALM7
- PURPLE: ALM6
- ORANGE: ALM5

**RS485 terminal:**

- YELLOW: RS485-
- GREEN: RS485+

**Power supply terminal:**

- RED: DC12V+
- BLACK: DC12V-

### 11.10 Electrification inspection

Connect video cable and control cable to the other equipments; Electrify DC12V power. The PTZ carries on self-testing and executes replacement procedure after power-on.

In the process of self-checking, camera will rotate horizontally and slowly for one and half cycle to the default original horizontal point which is set by factory, then upwardly turn to original vertical point, then downwardly to original horizontal point. Lens will be pulled from far focus to near focus to complete self-checking. The whole camera is absolutely steady means PTZ completed self-testing and ready to be controlled. If unstable, please refer to the troubleshooting in the operation manual appendix.

## 12. Maintenance service terms

### 1. Range of warranty

- The product will be maintained free for one year.
- The product will be obtained the free maintenance service if the same malfunction appears again within three months.
- Malfunction of products caused by force majeure (such as war, earthquake, lightning strike and so on ), abuse, non-standard operation, change of construction, non-normal wear or accident are non-free of warranty.
- Please prevent from the damage which is caused by heavy pressure , the fierce vibration and soaks in the process of transportation and storage, which does not belong to the free maintenance scope.
- Please adopt the way of fission package or original package to transport because the product damage dose not belong to the free maintenance scope if you use the whole packing way , not the original packing way.
- The maintenance services will not be free when the pan/tilt module is disassembled or serviced by the user voluntarily.
- Our company implements the lifetime payable service if the product in malfunction has surpassed the warranty period.
- To the products with defect :if it's in the period of warranty, please fill in the form of warranty information correctly, describe the trouble in details, and provide original sales. invoice or its copy.
- For the damage and loss which was caused by the user's specifically application, factory won't bear any risk and responsibility. The factory compensation made by breach of faith, negligence or tortious won't exceed the amount of the products. The factory won't bear any responsibility for the special, unexpected and continue damage caused by any other reasons.
- Our company has the final right of explanation for the above terms.

### 2. Warranty terms

- If the products are within the warranty time, the buyer should fill in the warranty card and send back together with the products.

### 3. Shipping

- If the product needs repaired , you can return it to the manufacturer through the supplier or directly. If you choose the later , please contact us in order to speed up the process. And our company only undertake the one-way freight from manufacturer to customer after maintenance.